

XENAX® Xvi 75V8S, XENAX® Xvi 75V8 and XENAX® Xvi 48V8 Bus coupling

Version 2.28

Edition 2. February 2024

CANopen over EtherCAT
CANopen over Powerlink
CANopen over CAN-Bus

EtherCAT®
ETHERNET
POWERLINK
CANopen®



XENAX® Ethernet servo controller with
EtherCAT® Busmodul

Functional Safety, TÜV certified
Force processes with „Force Limitation“,
„Force Monitoring“ and „Force Control“

This bus coupling manual describes the CANopen Protocol
stack of the XENAX® Xvi 75V8S, Xvi 48V8 and Xvi 75V8
servo controller.

The CANopen communication profile CiA DS301 as well as
the device profile CiA DS402 for drive and motion control
are described in detail.

EtherCAT and Powerlink over CANopen and CANopen
direct are available as Protocol stacks.

Ethernet 100 BASE-TX or CAN-Bus are used as physical
layers.

Contents

1	General	6
2	Bus module	6
2.1	CANopen Signals	6
2.2	Bus module LED status	7
2.3	Bus protocol upgrade	7
2.4	Bus protocol stacks on the website	8
2.5	XENAX bus protocol parameterization	8
3	CANopen communication profile DS301	9
3.1	Communication profile 1000 – 1FFF	9
3.1.1	Device Type, bus protocol, 1000h	9
3.1.2	Error bit register, 1001h	9
3.1.3	COB-ID SYNC, CANopen, 1005h	9
3.1.4	NMT_CycleLen_U32, Powerlink, 1006h	9
3.1.5	Manufacturer Device Name, 1008h	9
3.1.6	Manufacturer Hardware Version, 1009h	10
3.1.7	Manufacturer Software Version, 100Ah	10
3.1.8	COB-ID EMCY, CANopen, 1014h	10
3.1.9	Producer Heartbeat Time, CANopen, 1017h	10
3.1.10	Identity Object Record, 1018h	11
3.1.11	CFM_VerifyConfiguration, Powerlink, 1020h	11
3.1.12	NMT_InterfaceGroup_0h_REC Powerlink, 1030h	12
3.1.13	Server SDO Parameter 1, CANopen, 1200h	12
3.1.14	SDO_SequLayerTimeout, Powerlink, 1300h	12
3.1.15	SDO_CmdLayerTimeout, Powerlink, 1301h	13
3.1.16	Sync Manager Communication Type, 1C00h	13
3.1.17	Sync Manager PDO Assignment 0, 1C10h	13
3.1.18	Sync Manager PDO Assignment 1, 1C11h	13
3.1.19	Sync Manager PDO Assignment 2, 1C12h	13
3.1.20	Sync Manager PDO Assignment 3, 1C13h	14
3.2	Powerlink used Objects 1COB – 1FFF	14
3.2.1	DLL_CNLossSoC , 1COBh	14
3.2.2	DLL_CNCRCErrror, 1COFh	14
3.2.3	DLL_CNLossOfSocTolerance, 1C14h	14
3.2.4	NWL_IpAddrTable_0h, 1E40h	15
3.2.5	NWL_IpGroup, 1E4Ah	15
3.2.6	NMT_FeatureFlags, 1F82h	15
3.2.7	NMT_EPLVersion, 1F83h	15
3.2.8	NMT_CurrNMTState, 1F8Ch	15
3.2.9	NMT_EPLNodeID, 1F93h	16
3.2.10	NMT_CycleTiming, 1F98h	17
3.2.11	NMT_CNBasicEthernetTimeout, 1F99h	17
3.2.12	NMT_HostName, 1F9Ah	17
3.2.13	NMT_ResetCmd, 1F9Eh	17
3.3	XENAX® specific objects	18
3.3.1	S-Curve Profile, 2000h	18
3.3.2	Reserved, 2001h	18

3.3.3	Reserved, 2002h	18
3.3.4	Reserved, 2003h	18
3.3.5	XENAX® Error Number, 2004h	18
3.3.6	I_Force Actual LINAX®/ELAX®, 2005h	19
3.3.7	Process Status Register XENAX®, 2006h	19
3.3.8	PDO Cycle Time, 2007h	20
3.3.9	LINAX®/ELAX®/ROTAX® Motor Type, 2008h	20
3.3.10	Limit Force, 2009h	20
3.3.11	Force Actual Value LINAX®/ELAX®, 200Ah	20
3.4	XENAX® Command set	21
3.4.1	Direct Commands, no parameter, 5000h	21
3.4.2	Read Parameter, XENAX®, 5001h	22
3.4.3	Write Parameter, XENAX®, 5002h	24
3.4.4	Read / Write Parameter XENAX®, 5003h	24
3.4.5	Motor Parameter XENAX®, 5004h	28
3.4.6	SMU Parameter XENAX®, 5005h	28
3.4.7	XENAX® Xvi75V8S and Xvi48V8 Parameter, 5006h	29
3.4.8	Forceteq pro Parameter, 5010h	29
3.4.9	Signateq Sensor Model Type (SQSMT), 5011h	30
3.4.10	Signateq Sensor Serial Number (SQSSN), 5012h	30
3.4.11	Tell Error String to the current Error (TES), 5020h	30
3.4.12	Set servo identification string (SID), 5021h	30
4	CANopen motion control DS402	31
4.1	State machine	31
4.2	Objects device profile DS402	32
4.2.1	Error Code, 603Fh	32
4.2.2	Controlword, 6040h	32
4.2.3	Statusword, 6041h	33
4.2.4	Modes of Operation Requested, 6060h	33
4.2.5	Modes of Operation Display, 6061h	33
4.2.6	Position Actual Value, 6064h	34
4.2.7	Following Position Error Window, 6065h	34
4.2.8	Target Position Window, 6067h	34
4.2.9	Position Window Time (PWT), 6068h	34
4.2.10	Velocity Actual Value, 606Ch	34
4.2.11	Limit I_Force, 6073h	35
4.2.12	Motor Current Actual Value, 6078h	35
4.2.13	Target Position/Distance, 607Ah	35
4.2.14	Soft-Limit Positions, 607Dh	35
4.2.15	Speed, Jog or Profile Position Mode, 6081h	36
4.2.16	Acceleration, Jog or Profile Position Mode, 6083h	36
4.2.17	Deceleration, Jog or Profile Position Mode, 6084h	36
4.2.18	Deceleration, Quick Stop, 6085h	36
4.2.19	Reference Methods, 6098h	37
4.2.20	Reference Speeds, Rotative Motors 6099h	37
4.2.21	Reference Acceleration, 609Ah	37
4.2.22	Velocity offset, Cyclic Sync Position Mode, 60B1h	38
4.2.23	Torque Offset, Cyclic Sync Position Mode, 60B2h	38
4.2.24	Synchronous Cycle Time, 60C2h	39
4.2.25	Actual Position Following Error, 60F4h	39
4.2.26	Digital Inputs XENAX®, 60FDh	40

4.2.27	Digital Outputs XENAX®, 60FEh	40
4.2.28	Target Velocity, 60FFh	41
4.2.29	Supported Modes of Operation, 6502h	41
4.2.30	Product Website Address, 6505h	41
5	Modes of Operation	42
5.1	Reference Mode	42
5.1.1	Reference of LINAX® / ELAX® linear motor axes	42
5.1.2	Example REFERENCE LINAX® single axes	42
5.1.3	Reference of LINAX® gantry systems	43
5.1.4	Example of Reference LINAX® gantry systems	43
5.1.5	Reference of rotative third party motors	44
5.1.6	Example of Reference rotative thirt party motors	44
5.1.7	Reference of ROTAX® Rxvp rotary motor	45
5.1.8	Reference of ROTAX® Rxhq rotary motor	45
5.1.9	Example of Reset Reference Failure	45
5.2	Profile Position Mode	46
5.2.1	Example of profile position mode	46
5.2.2	Example of Reset Profile Position Mode Failure	46
5.2.3	Example of “Halt” in profile position mode	47
5.3	Cyclic Synchronous Position Mode	48
5.3.1	Example of cyclic synchronous position mode	48
5.3.2	Reset Cyclic Synchronous Position Mode Failure	48
5.4	Jog Mode Jenny Science specific	49
5.4.1	Example of Jog Mode Jenny Science specific	49
5.4.2	Example of Reset Jog Mode Failure	49
6	Force Process Forceteq®	50
6.1	Forceteq® basic	50
6.1.1	I_Force Calibration	50
6.1.2	Force Limitation	51
6.1.3	Force Monitoring	52
6.2	Forceteq® pro	53
6.2.1	I_Force Calibration	53
6.2.2	Force Limitation	54
6.2.3	Force Monitoring	55
7	EtherCAT	56
7.1	Predefined EtherCAT PDO	56
7.1.1	EtherCAT in Profile Position Mode	56
7.1.2	EtherCAT in Cyclic synchronous Position Mode	56
7.1.3	EtherCAT Object detail Receive PDO	57
7.1.4	EtherCAT Object detail Transmit PDO	58
8	Powerlink	60
8.1	Powerlink PDO Parameter	60
8.1.1	Powerlink PDO_RxCommParam_0h, 1400h	60
8.1.2	Powerlink PDO_RxMappParam_0h, 1600h	60
8.1.3	Powerlink PDO_TxCommParam_0h, 1800h	61
8.1.4	Powerlink PDO_TxMappParam_0h, 1A00h	61
9	CANopen	62
9.1	CANopen PDO Parameter	62

9.1.1	CANopen Receive PDO Comm Param 1, 1400h	62
9.1.2	CANopen Receive PDO Comm Param 2, 1401h	62
9.1.3	CANopen Receive PDO Comm Param 17-24, 1410h-1417h	62
9.1.4	CANopen Receive PDO Mapping Param 1, 1600h	63
9.1.5	CANopen Receive PDO Mapping Param 2, 1601h	63
9.1.6	CANopen Receive PDO Mapping Param 17, 1610h	63
9.1.7	CANopen Receive PDO Mapping Param 18, 1611h	63
9.1.8	CANopen Receive PDO Mapping Param 19, 1612h	63
9.1.9	CANopen Receive PDO Mapping Param 20, 1613h	64
9.1.10	CANopen Receive PDO Mapping Param 21, 1614h	64
9.1.11	CANopen Receive PDO Mapping Param 24, 1617h	64
9.1.12	CANopen Transmit PDO Comm Param 1, 1800h	65
9.1.13	CANopen Transmit PDO Comm Param 2, 1801h	65
9.1.14	CANopen Transmit PDO Comm Param 17-24, 1810h - 1817h	65
9.1.15	CANopen Transmit PDO Mapping Param 1, 1A00h	66
9.1.16	CANopen Transmit PDO Mapping Param 2, 1A01h	66
9.1.17	CANopen Transmit PDO Mapping Param 17, 1A10h	66
9.1.18	CANopen Transmit PDO Mapping Param 20, 1A13h	66
9.1.19	CANopen Transmit PDO Mapping Param 21, 1A14h	66
9.1.20	CANopen Transmit PDO Mapping Param 23, 1A16h	67
9.1.21	CANopen Transmit PDO Mapping Param 24, 1A17h	67
9.2	Predefined CANopen PDO	68
9.2.1	CANopen in Profile Position Mode	68

1 General

The XENAX® Xvi 75V8/S and the XENAX® Xvi 48V8 servo controller use an optional bus module for coupling the drive to different bus systems, like EtherCAT, Powerlink or CANopen.

The CANopen protocol with DS301 and DS402 is the central, common layer for the protocol stacks.

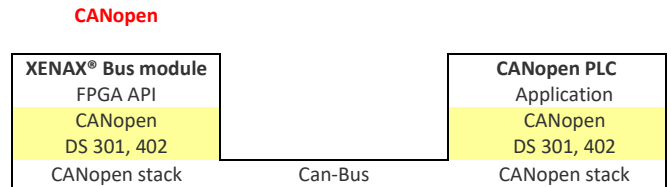
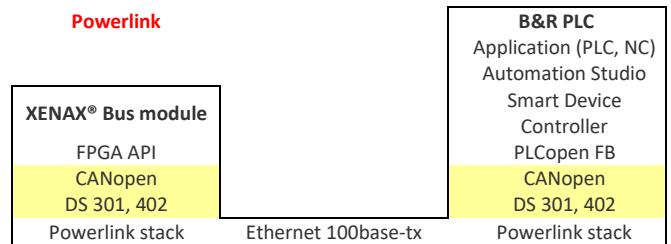
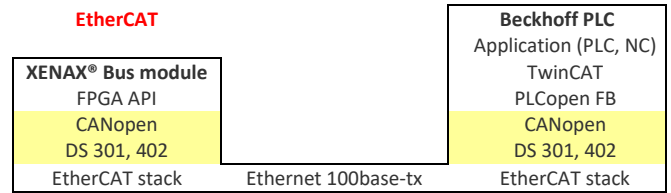

2 Bus module

EtherCAT (article no. 130 10 00)
Powerlink (article no. 130 10 10)

CANopen (article no. 130 10 05)

The protocol stack can be updated by WebMotion via Webbrowser or the [JSC Ethernet Installer](#).



2.1 CANopen Signals

A 120ohm terminating resistor is integrated. To activate this, an external bridge from CAN-Termination_1 (Pin 1) and CAN-Termination_2 (Pin 4) is necessary.

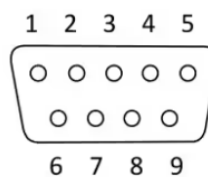

PIN	Signal
1	CAN-Termination_1
2	CAN_L
3	CAN_GND
4	CAN-Termination_2
5	CAN_SHLD
6	No Connection
7	CAN_H
8	No Connection
9	No Connection

2.2 Bus module LED status

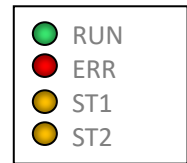

	RUN	ERR	ST1 Jenny Science specific	ST2 Jenny Science specific
EtherCAT				
<OFF>	In init process or no power	Bus module operable		Bus module ready
<ON>	Operational state	State bus off	No application in the flash	
<BLINK>	Pre-Operational state	Internal EEPROM blank		Protocol download in progress
Powerlink				
	RUN (STAT)	ERR	ST1 Jenny Science specific	ST2 Jenny Science specific
<OFF>	In init process or no power	Bus module no error		Bus module ready
<ON>	Operational state	State bus off	No application in the flash	
<BLINK>	Pre-Operational state			Protocol download in progress
CANopen				
	RUN	ERR	ST1 Jenny Science specific	ST2 Jenny Science specific
<OFF>	In init process or no power	Bus module no error		unused
<ON>	Operational state	State bus off	No application in the flash	
<BLINK>	Pre-Operational state			

2.3 Bus protocol upgrade

At delivery time of XENAX® servo controller, the latest bus protocol stack version is installed in the bus module.

An upgrade could be installed with WebMotion in menu *firmware / update -> BUS-MODULE* or by the the [JSC Ethernet Installer](#).

The bus protocol software *Xenax_XXXXXXX_protocol_Vx.x.flash* is available on www.jennyscience.ch.

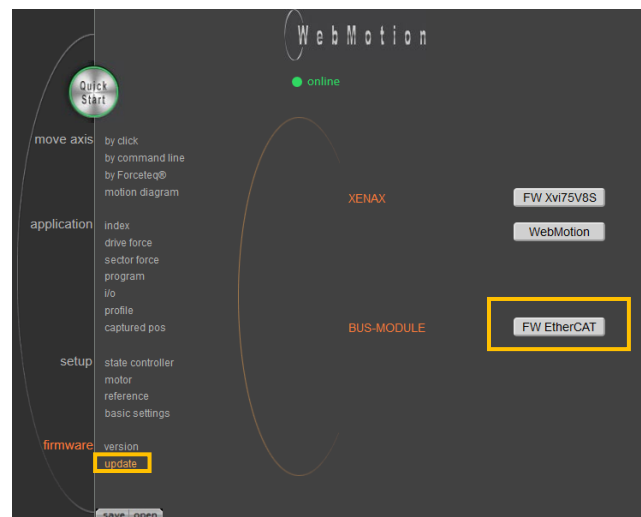

Important:

The upgraded bus protocol version has to be activated by power OFF and power ON. You could check the installed version with WebMotion in menu *firmware / version-> BUS-MODULE*



2.4 Bus protocol stacks on the website

Each protocol stack is provided on the website for download. It includes the bus module protocol stack software together with the electronic datasheets.

EtherCAT	Xenax_EtherCAT.eds	Electronic datasheet of CANopen interface
	Xenax_EtherCAT.xml	XML device description
	Xenax_EtherCAT_eeprom.bin	Slave information interface, stored data in EEPROM
	Xenax_EtherCAT_protocol_Vx.xx.flash	EtherCAT firmware of the busmodule
Powerlink	Xenax_Powerlink.xdd	XML based device description for Powerlink
	Xenax_Powerlink_protocol_Vx.xx.flash	Powerlink firmware of the busmodule
CANopen	Xenax_CANopen.eds	Electronic datasheet of CANopen interface
	Xenax_CANopen.xdd	XML based device description
	Xenax_CANopen_protocol_Vx.xx.flash	CANopen firmware of the busmodule

2.5 XENAX bus protocol parameterization

The parameterization is depended on the type of protocol stack.

The actual value can be checked with the additional character “?” at the end of the terminal command.
For example, PCT?

	XENAX® bus protocol parameter		Unit	Bus protocol specific relevance
EtherCAT	PCT	PDO cycle time	µs	The master device (i.e. TwinCAT) writes the position cycle time into the object 0x60C2. Typical values: 200, 500,1000
Powerlink	PCT	PDO cycle time	µs	The Powerlink Managing Node (MN) writes the position cycle time into hidden object 0x1006 that is automatic forwarded to object 0x2007
	CI	Card Identifier	-	Powerlink Node number, default = 0 Range: 1-99
CANopen	CAB	CAN Baud rate	-	Available CAN Baudrates: 10'000 20'000 50'000 125'000 250'000 500'000 800'000 1'000'000 Default: 500'000
	CI	Card Identifier	-	CAN Node ID, default = 0 Range: 1-99

3 CANopen communication profile DS301

3.1 Communication profile 1000 – 1FFF

3.1.1 Device Type, bus protocol, 1000h

The lower 16 bit contains the device profile number and the upper 16 bit additional information.

Data Type	Access (PreOp/SafeOp/Op)	PDO Mapping	Default Value	Lower Limit	Upper Limit
Unsigned 32	RO/RO/RO	no	0x00420192 (EtherCAT) 0x00020192 (CANopen) 0x00020192 (Powerlink)	0x00000000	0xFFFFFFFF

3.1.2 Error bit register, 1001h

Data Type	Access (PreOp/SafeOp/Op)	PDO Mapping	Default Value	Low Limit	Up Limit
Unsigned 8	RO/RO/RO	no	0x00	0x00	0xFF

0	generic error
1	current
2	voltage
3	temperature
4	communication (overrun)
5	device profile specific
6	reserved
7	manufacturer specific

3.1.3 COB-ID SYNC, CANopen, 1005h

COB-ID of the Synchronization object.
The device generates a SYNC message if bit 30 is set. The meaning of other bits is equal to the other communication objects.

Data Type	Access	PDO Mapping	Default Value	Lower Limit	Upper Limit
Unsigned 32	RW	no	0x80000080	0x00000001	0xFFFFFFFF

3.1.4 NMT_CycleLen_U32, Powerlink, 1006h

Data Type	Access (PreOp/SafeOp/Op)	PDO Mapping	Default Value	Lower Limit	Upper Limit
Unsigned 32	RW	no	0x3E8	0x64	0x186A0

3.1.5 Manufacturer Device Name, 1008h

Data Type	Access (PreOp/SafeOp/Op)	PDO Mapping	Value	Lower Limit	Upper Limit
VISIBLE_STRING	RO/RO/RO	no	Servocontroller XENAX Xvi xxVx*	0	0

*depends on the host controller

3.1.6 Manufacturer Hardware Version, 1009h

This object contains the hardware version of:
XENAX servo controller and BUS-Module

DataType	Access (PreOp/SafeOp/Op)	PDO Mapping	Value
VISIBLE_STRING	RO/RO/RO	no	BUS Module HW Vxxx.xxx

3.1.7 Manufacturer Software Version, 100Ah

This object contains the software version of:
XENAX Firmware, Bus-Module software, SMU-Module
software (optional)

DataType	Access (PreOp/SafeOp/Op)	PDO Mapping	Value
VISIBLE_STRING	RO/RO/RO	no	BUS Protocol SW Vxxx.xxx

3.1.8 COB-ID EMCY, CANopen, 1014h

COB-ID used for emergency message

DataType	Access (PreOp/SafeOp/Op)	PDO Mapping	Default Value
Unsigned 32	RO/RO/RO	no	0x00000080

3.1.9 Producer Heartbeat Time, CANopen, 1017h

Defines the cycle time of the heartbeat. If the time is 0 it is
not used. The time has to multiply by 1 msec

DataType	Access (PreOp/SafeOp/Op)	PDO Mapping	Default Value
Unsigned 32	RO/RO/RO	no	0x00000000

3.1.10 Identity Object Record, 1018h

Sub-index 1
contains a unique value allocated to the manufacturer
depends on the used protocol.

Sub-index 2
identifies the host controller platform.

Sub-index 3
identifies the hardware revision of the host controller
platform.

Sub-index 4
identifies a manufacturer specific serial number.

Sub-index	Description	Data Type	Access (PreOp/SafeOp/Op)	Default Value	Lower Limit	Upper Limit
000	Nbr of Entries	Unsigned 8	RO/RO/RO	0x04	0x1	0x4
001	Vendor Id	Unsigned 32	RO/RO/RO	0x00000xxx	0x0	0xFFFFFFFF
002	Product Code	Unsigned 32	RO/RO/RO	0x4808 0x7508 0x7509	0x0	0xFFFFFFFF
003	Revision Number	Unsigned 32	RO/RO/RO	0x00010000	0x0	0xFFFFFFFF
004	Serial Number	Unsigned 32	RO/RO/RO	0x1 (not used)	0x0	0xFFFFFFFF

3.1.11 CFM_VerifyConfiguration, Powerlink, 1020h

CFM_VerifyConfiguration contains device local configuration date and time. The object may be implemented on each Ethernet Powerlink Node.

Sub-index	Description	Data Type	Access	PDO Mapping	Default Value
000	Nbr of Entries	CVM_VERIFY_CONFIGURATION_T	RO	no	0x04
001	ConfDate_U32	Unsigned 32	RW	no	0x0
002	ConfTime_U32	Unsigned 32	RW	no	0x0
003	ConfID_U32	Unsigned 32	RW	no	0x0
004	VerifyConfInvalid_U32	Unsigned 32	RW	no	0x1

3.1.12 NMT_InterfaceGroup_0h_REC Powerlink, 1030h

The InterfaceGroup_REC object is a subset of the Interface Group RFC1213

Sub-index	Description	Data Type	Access	PDO Mapping	Default Value
000	Nbr of Entries	NMT_INTERFACE GROUP_T	RO	no	0x09
001	InterfaceIndex_U16	Unsigned 16	RO	no	0x1
002	InterfaceDescription_VSTR	VISIBLE_STRING	RO	no	0
003	InterfaceType_U8	Unsigned 8	RO	no	0x6
004	InterfaceMtu_U32	Unsigned 16	RO	no	0x286
005	InterfacePhysAddress_OSTR	OCTET_STRING	RO	no	0
006	InterfaceName_VSTR	VISIBLE_STRING	RO	no	0
007	InterfaceOperStatus_U8	Unsigned 8	RO	no	0x0
008	InterfaceAdminState_U8	Unsigned 8	RO	no	0x1
009	Valid_BOOL	BOOLEAN	RO	no	0x0

3.1.13 Server SDO Parameter 1, CANopen, 1200h

The object contains the served SDO parameters.

Sub-index	Description	Data Type	Access (PreOp/SafeOp/Op)	PDO Mapping	Default Value
000	Nbr of Entries	SDO_PARAMETER	RO	no	0x02
001	COB-ID Client -> Server	Unsigned 32	RO	no	0x00000600
002	COB-ID Server -> Client	Unsigned 32	RO	no	0x00000580

3.1.14 SDO_SequLayerTimeout, Powerlink, 1300h

The object provides a timeout value in [ms] for the connection abort recognition of the SDO sequence layer. The object shall be implemented if SDO communication via UDP/IP or EPL-ASnd is supported.

Data Type	Access	Unit	PDO Mapping	Default Value
Unsigned 32	RW	ms	no	0x000007D0

3.1.15 SDO_CmdLayerTimeout, Powerlink, 1301h

The object provides a timeout value in ms for the connection abort recognition of the SDO commandlayer.

Data Type	Access	Unit	PDO Mapping	Default Value
Unsigned 32	RW	ms	no	0x000003E8

3.1.16 Sync Manager Communication Type, 1C00h

Up to 32 sync manager types can be described. The first 4 sync manager are fixed and the following can be configured to one type out of the first four. The default configuration is:

1	mailbox receive
2	mailbox send
3	process data output
4	process data input

Sub-index	Name	Data Type	Access (PreOp/SafeOp/Op)	Default Value	Lower Limit	Upper Limit
000	No of Used Sync Manager Channels	Unsigned 8	RO/RO/RO	0x05	0x00	0x20
001	Com Type Sync Manager 1	Unsigned 8	RO/RO/RO	0x1	0x0	0x4
002	Com Type Sync Manager 2	Unsigned 8	RO/RO/RO	0x2	0x0	0x4
003	Com Type Sync Manager 3	Unsigned 8	RO/RO/RO	0x3	0x0	0x4
004	Com Type Sync Manager 4	Unsigned 8	RO/RO/RO	0x4	0x0	0x4
005	Com Type Sync Manager 5	Unsigned 8	RO/RO/RO	0x0	0x0	0x4

3.1.17 Sync Manager PDO Assignment 0, 1C10h

Using this object PDOs can be assigned to the Sync Managers starting at Sync Manager 2.

Sub-index	Description	Data Type	Access (PreOp/SafeOp/Op)	Default Value	Lower Limit	Upper Limit
000	Nbr of Entries	Unsigned 16	RO/RO/RO	0x00	0x00	0x00

3.1.18 Sync Manager PDO Assignment 1, 1C11h

Sub-index	Description	Data Type	Access (PreOp/SafeOp/Op)	Default Value	Lower Limit	Upper Limit
000	Nbr of Entries	Unsigned 16	RO/RO/RO	0x00	0x00	0x00

3.1.19 Sync Manager PDO Assignment 2, 1C12h

Sub-index	Description	Data Type	Access (PreOp/SafeOp/Op)	Default Value	Lower Limit	Upper Limit
000	Nbr of Assigned RxPDO	Unsigned 16	RW/RW/RW	0x01	0x00	0x06
001	PDO Mapping Index of Assigned RxPDOs	Unsigned 16	RW/RW/RW	0x1601	0x1600	0x17FF

3.1.20 Sync Manager PDO Assignment 3, 1C13h

Sub-index	Description	Data Type	Access (PreOp/SafeOp/Op)	Default Value	Lower Limit	Upper Limit
000	Nbr of Assigned TxPDO	Unsigned 16	RW/RW/RW	0x01	0x00	0x05
001	PDO Mapping Index of Assigned TxPDOs	Unsigned 16	RW/RW/RW	0x1A13	0x1A00	0x1BFF

3.2 Powerlink used Objects 1C0B – 1FFF

3.2.1 DLL_CNLossSoC , 1C0Bh

The following objects are used to monitor loss of Soc error symptoms detected by a CN. The record consists of a cumulative counter and a threshold counter data object and its threshold data object.

Sub-index	Description	Data Type	Access	Default Value
000	NumberOfEntries	DLL_ERR_CNTREC_T	RO	0x03
001	CumulativeCnt_U32	Unsigned 32	RW	0x00
002	ThresholdCnt_U32	Unsigned 32	RO	0x00
003	Threshold_U32	Unsigned 32	RW	0x0F

3.2.2 DLL_CNCRCErrror, 1C0Fh

The following objects are used to monitor CRC errors.

Sub-index	Description	Data Type	Access	Default Value
000	NumberOfEntries	DLL_ERR_CNTREC_T	RO	0x03
001	CumulativeCnt_U32	Unsigned 32	RW	0x00
002	ThresholdCnt_U32	Unsigned 32	RO	0x00
003	Threshold_U32	Unsigned 32	RW	0x0F

3.2.3 DLL_CNLossOfSocTolerance, 1C14h

Data Type	Access	Unit	PDO Mapping	Default Value
Unsigned 32	RW	ns	no	0x5F5E100

3.2.4 NWL_IpAddrTable_0h, 1E40h

The IP address table contains this entity's IP addressing information. The NWL_IpAddrTable_Xh object is a subset of the IP Group RFC1213. It assigns IP parameters to an interface indicated by NMT_ItfGroup_Xh.

Sub-index	Description	Data Type	Access	Default Value
000	NumberOfEntries	NWL_IP_ADDR_TABLE_T	RO	0x05
001	IfIndex_U16	Unsigned 16	RO	0x01
002	Addr_IPAD	IP_ADDRESS	RW	0x00
003	Netmask_IPAD	IP_ADDRESS	RW	0xFFFFFFFF00
004	ReasmMaxSize_U16	Unsigned 16	RO	0x11E
005	DefaultGateway_IPAD	IP_ADDRESS	RW	0xCOA864FE

3.2.5 NWL_IpGroup, 1E4Ah

The NWL_IpGroup_REC object is a subset of the IP Group RFC1213. The object specifies information about the IP stack.

Sub-index	Description	Data Type	Access	Default Value
000	NumberOfEntries	NWL_IP_GROUP_T	RO	0x03
001	Forwarding_BOOL	BOOLEAN	RW	0x00
002	DefaultTTL_U16	Unsigned 16	RW	0x40
003	ForwardDatagrams_U32	Unsigned 32	RO	0x00

3.2.6 NMT_FeatureFlags, 1F82h

Data Type	Access	PDO Mapping	Default Value
Unsigned 32	RO	no	0x00000247

3.2.7 NMT_EPLVersion, 1F83h

Data Type	Access	PDO Mapping	Default Value
Unsigned 8	RO	no	0x20

3.2.8 NMT_CurrNMTState, 1F8Ch

Data Type	Access	PDO Mapping	Default Value
Unsigned 8	RO	no	0x1C

3.2.9 NMT_EPLNodeID, 1F93h

The object stores the devices's EPL NodeID.

Sub-index 01h: NodeID_U8:

The Sub-index holds the device's actual Node ID. NodeID_U8 may be provided by hardware settings (dip switch etc.) or set up by software.

Sub-index 02h: NodeIDByHW_BOOL:

The Sub-index displays the NodeID setup mode of the device. It shall be setup during system initialisation.

On devices, that setup the EPL NodeID exclusively by HW, the object Sub-index be set to TRUE.

On devices, that setup the EPL NodeID exclusively by SW, the object Sub-index be set to FALSE.

On devices, that enable SW EPL NodeID setup by a special HW setup, the Sub-index shall be set to FALSE, if EPL NodeID setup by SW is enabled.

If SW EPL NodeID setup is enabled by a NodeID HW switch, it's recommended to use NodeID setup = 0.

The ability to define the EPL NodeID by SW shall be indicated in the object dictionary entry

NMT_FeatureFlags_U32 Bit 10. HW setup ability is indicated in the device description by D_NMT_NodeIDByHW_BOOL .

Sub-index	Description	Data Type	Access	Default Value
000	NumberOfEntries	NMT_EPLNODEID_TYPE	RO	0x02
001	NodeID_U8	Unsigned 8	RO	0x01
002	NodeIDByHW_BOOL	BOOLEAN	RO	0x00

3.2.10 NMT_CycleTiming, 1F98h

NMT_CycleTiming_REC provides node specific timing parameters, that influence the EPL cycle timing.

All entries must be supported by a CN.

On the MN, some of the entries are irrelevant.

Sub-index	Description	Data Type	Access	Default Value
000	NumberOfEntries	NMT_CYCLE_TIMING_T	RO	0x09
001	IsochrTxMaxPayload_U16	Unsigned 16	RO	0x24
002	IsochrRxMaxPayload_U16	Unsigned 16	RO	0x24
003	PResMaxLatency_U32	Unsigned 32	RO	0x00
004	PReqActPayloadLimit_U16	Unsigned 16	RW	0x24
005	PResActPayloadLimit_U16	Unsigned 16	RW	0x24
006	ASndMaxLatency_U32	Unsigned 32	RO	0x00
007	MultiplCycleCnt_U8	Unsigned 8	RW	0x00
008	AsyncMTUSize_U16	Unsigned 16	RW	0x12C
009	Prescaler_U16	Unsigned 16	RW	0x2

3.2.11 NMT_CNBasicEthernetTimeout, 1F99h

Provide the time in us to be applied before changing from NMT_CS_NOT_ACTIVE to NMT_CS_BASIC_ETHERNET.

Data Type	Access	PDO Mapping	Default Value
Unsigned 32	RW	no	0x4C4B40

3.2.12 NMT_HostName, 1F9Ah

Provides the node's DNS host name.

Data Type	Access	PDO Mapping	Default Value
VISIBLE_STRING	RW	no	0

3.2.13 NMT_ResetCmd, 1F9Eh

NMT_ResetCmd may be used to initiate the reset of a node. Setting NMT_ResetCmd to the NMT Command ID NMTResetNode, NMTResetConfiguration, NMTResetCommunication or NMTSwReset shall trigger the node internal generation of a respective NMT command to itself. NMT_ResetCmd shall be automatically reset to NMTInvalidService by the node, when the reset has been completed. On read access, NMT_ResetCmd will always show NMTInvalidService. If applied in NMT_CS_EPL_MODE or NMT_MS_EPL_MODE, resets by NMT_ResetCmd may violate the NMT rules and stimulate DLL and NMT Guarding errors.

Data Type	Access	PDO Mapping	Default Value
Unsigned 8	RW	no	0xFF

3.3 XENAX® specific objects

3.3.1 S-Curve Profile, 2000h

This object indicates the commanded S-curve parameter (0-100%) during the acceleration / deceleration ramp. This parameter is used in the profile position mode only.

Data Type	Access (PreOp/SafeOp/Op)	PDO Mapping	Default Value	Lower Limit	Upper Limit
Unsigned 32	RW/RW/RW	RxPDO / TxPDO	0x14	0x1	0x64

3.3.2 Reserved, 2001h

Currently not implemented, reserved for future use.

Data Type	Access (PreOp/SafeOp/Op)	PDO Mapping	Default Value	Lower Limit	Upper Limit
Unsigned 32	RW/RW/RW	RxPDO / TxPDO	0x00	0x00000000	0xFFFFFFFF

3.3.3 Reserved, 2002h

Currently not implemented, reserved for future use.

Data Type	Access (PreOp/SafeOp/Op)	PDO Mapping	Default Value	Lower Limit	Upper Limit
Unsigned 32	RW/RW/RW	RxPDO / TxPDO	0x00	0x00000000	0xFFFFFFFF

3.3.4 Reserved, 2003h

Currently not implemented, reserved for future use.

Data Type	Access (PreOp/SafeOp/Op)	PDO Mapping	Default Value	Lower Limit	Upper Limit
Unsigned 32	RW/RW/RW	RxPDO / TxPDO	0x00	0x00000000	0xFFFFFFFF

3.3.5 XENAX® Error Number, 2004h

Check XENAX Manual of the used Xvi for detailed information about the Error Numbers

Data Type	Access	PDO Mapping	Default Value	Lower Limit	Upper Limit
INTEGER 8	RO/RO/RO	no	0x00	0x0	0x7F

3.3.6 I_Force Actual LINAX®/ELAX®, 2005h

I Force Actual value in [mA] units

DataType	Access (PreOp/SafeOp/Op)	PDO Mapping	Default Value	Lower Limit	Upper Limit
INTEGER32	RO/RO/RO	TxPDO	0x00	0x80000000	0x7FFFFFFF

3.3.7 Process Status Register XENAX®, 2006h

Binary coded definition of PSR (Process Status Register)

DataType	Access (PreOp/SafeOp/Op)	PDO Mapping	Default Value	Lower Limit	Upper Limit
INTEGER32	RO/RO/RO	TxPDO	0x00	0x80000000	0x7FFFFFFF

Bit 0	ERROR
Bit 1	REFERENCE
Bit 2	IN_MOTION
Bit 3	IN_POSITION
Bit 4	END_OF_PROGRAM
Bit 5	IN_FORCE
Bit 6	IN_SECTOR
Bit 7	FORCE_IN_SECTOR
Bit 8	INVERTER_VOLTAGE
Bit 9	END_OF_GANTRY_INIT
Bit 10	NEGATIVE_LIMIT_SWITCH
Bit 11	POSITIVE_LIMIT_SWITCH
Bit 12	EMERGENCY_EXIT_1, REMAIN POWER ON (Function can only be used without bus module. With bus module, apply function "EMERGENCY_EXIT").
Bit 13	EMERGENCY_EXIT, POWER OFF
Bit 14	FORCE_CALIBRATION_ACTIVE
Bit 15	I_FORCE_LIMIT_REACHED
Bit 16	STO PRIMED/HIT
Bit 17	SS1 PRIMED/HIT
Bit 18	SS2 PRIMED
Bit 19	SS2 HIT
Bit 20	SLS PRIMED
Bit 21	SLS SPEED HIT
Bit 22	SLS POSITION HIT
Bit 23	WARNING
Bit 24	INFORMATION
Bit 25	PHASING DONE
Bit 26	I_FORCE_DRIFT_COMPENSATION_DRIVE_ACTIVE
Bit 27	FORCE_LIMIT_REACHED
Bit 28-31	unused

3.3.8 PDO Cycle Time, 2007h

PDO update cycle time in [μ s] units

Data Type	Access (PreOp/SafeOp/Op)	PDO Mapping	Default Value	Lower Limit	Upper Limit
Unsigned 16	RW/RW/RW	no	0x3E8	0x64	0x2710

3.3.9 LINAX®/ELAX®/ROTAX® Motor Type, 2008h

This object indicates the type motor axis connected to the XENAX® servo controller. Jenny Science axes will return a motor id while third party axes return the string “rotative”.

Data Type	Access (PreOp/SafeOp/Op)	PDO Mapping	Default Value	Lower Limit	Upper Limit
VISIBLE_STRING	RO/RO/RO	no	-	0	0

3.3.10 Limit Force, 2009h

Limited Force value in [**mN**] units (only Xvi75V8S with Signateq®)

Data Type	Access (PreOp/SafeOp/Op)	PDO Mapping	Default Value	Lower Limit	Upper Limit
Integer 32	RW/RW/RW	RxPDO / TxPDO	0x00	0x80000000	0x7FFFFFFF

3.3.11 Force Actual Value LINAX®/ELAX®, 200Ah

Force Actual value in [**mN**] units (only Xvi75V8S with Signateq®)

Data Type	Access (PreOp/SafeOp/Op)	PDO Mapping	Default Value	Lower Limit	Upper Limit
Integer 32	RO/RO/RO	TxPDO	0x00	0x80000000	0x7FFFFFFF

3.4 XENAX® Command set

3.4.1 Direct Commands, no parameter, 5000h

This object contains commands without any additional parameters. The object value represents the command.

See manual for detailed information.

Data Type	Access (PreOp/SafeOp/Op)	PDO Mapping	Default Value	Lower Limit	Upper Limit
Unsigned 32	RW/RW/RW	no	0x0	0x0	0xFFFFFFFF
Ref/Power					
0x1000	Reference, Linax: Program sequence for Power On, search electrical angle (phasing) and calculate absolute position. Mandatory for first startup of LINAX®/ELAX® linear motor axes after power on. Rotative: Reference on reference sensor and/or Z-Mark, according WebMotion menu reference				
0x1020	RSTO Limit stop, mechanical reference for Linax				
0x1030	MLC Mechanical Limit Calibration				
0x1040	reserved				
0x1050	AREF1 Automatic Reference when entering Mode 6 (Used f.e. with OMRON)				
Power					
0x2000	PW Power On (for rotative motors only)				
0x2010	PWC Power continues at actual position (linear motor axes, after error, or after PQ)				
0x2020	PWR Power Reset (search electrical angle, phasing, for test only)				
0x2030	PQ Power Quit				
Motion					
0x3000	GP Go Position				
0x3010	GW Go Way				
0x3020	JP Jog Positive				
0x3030	JN Jog Negative				
0x3040	SM Stop Motion				
0x3050	GZ Rotate to Z-Mark				
0x3060	reserved				
Cogging					
0x4000	FC Force Calibration (distance parameter is WA)				
0x4001	FCT1 Force Calibration Test Mode on (with active compensation)				
0x4002	FCT0 Force Calibration Test Mode off (position controller active)				
0x4003	FCT2 Force Calibration Test Mode on (without active compensation)				
0x4010	IFDCP Automatic I_Force Drift Compensation Drive in positive direction				
0x4011	IFDCN Automatic I_Force Drift Compensation Drive in negative direction				
Init					
0x5000	RES Reset				
0x5001	RESM Reset Motor Specific Settings				
0x5010	CLCP Clear all Captured Positions				
0x5015	CP12 Captured Position Input 12 on (Xvi75V8 or Xvi75V8S) / CP4 Captured Position Input 4 on (Xvi48V8)				
0x5016	CP12 Captured Position Input 12 off (Xvi75V8 or Xvi75V8S) / CP4 Captured Position Input 4 off (Xvi48V8)				
0x5020	CLPO Clear position counter (only rotative motors)				
0x5030	DMBUS Deactivate Motion Blocking by Unconfigured SMU				
Force control					
0x6000	Start force monitoring in cyclic synchronized position mode				
0x6001	Finish force monitoring in cyclic synchronized position mode. Drive since last start command 0x6000 will be analysed, for example bit 7 in PSR (Force in Sector) gets valid value				
0x6002	TPSO Take Position as Sector Offset				
0x6010	CLFO Clear Force Offset				
Bootloader					
VARAN only					
0x7000	1 st value, Prepare Bootloader activation				
0x7001	2 nd value, Start Bootloader				

3.4.2 Read Parameter, XENAX®, 5001h

The Sub-indexes represent the specific parameter.

Sub-index	Description	Data Type	Access PreOp/SafeOp/Op	PDO Map	Default Value	Lower Limit	Upper Limit
000	NumOfEntries	INTEGER32	RO/RO/RO	no	0x29	0x0	0x7FFFFFFF
001	TS Tell Status	INTEGER32	RO/RO/RO	no	0x00	0x80000000	0x7FFFFFFF
002	TE Tell Error Number	INTEGER32	RO/RO/RO	no	0x00	0x80000000	0x7FFFFFFF
003	TP Tell Position	INTEGER32	RO/RO/RO	no	0x00	0x80000000	0x7FFFFFFF
004	TT Tell Temperature	INTEGER32	RO/RO/RO	no	0x00	0x80000000	0x7FFFFFFF
005	TOX Tell Output Hex	INTEGER32	RO/RO/RO	no	0x00	0x80000000	0x7FFFFFFF
006	TIX Tell Input Hex	INTEGER32	RO/RO/RO	no	0x00	0x80000000	0x7FFFFFFF
007	TMC Tell Motor Current	INTEGER32	RO/RO/RO	no	0x00	0x80000000	0x7FFFFFFF
008	TMT Tell Motion Time	INTEGER32	RO/RO/RO	no	0x00	0x80000000	0x7FFFFFFF
009	TCP Tell Captured Position 1	INTEGER32	RO/RO/RO	no	0x00	0x80000000	0x7FFFFFFF
010	TCP Tell Captured Position 2	INTEGER32	RO/RO/RO	no	0x00	0x80000000	0x7FFFFFFF
011	TCP Tell Captured Position 3	INTEGER32	RO/RO/RO	no	0x00	0x80000000	0x7FFFFFFF
012	TCP Tell Captured Position 4	INTEGER32	RO/RO/RO	no	0x00	0x80000000	0x7FFFFFFF
013	TCP Tell Captured Position 5	INTEGER32	RO/RO/RO	no	0x00	0x80000000	0x7FFFFFFF
014	TCP Tell Captured Position 6	INTEGER32	RO/RO/RO	no	0x00	0x80000000	0x7FFFFFFF
015	TCP Tell Captured Position 7	INTEGER32	RO/RO/RO	no	0x00	0x80000000	0x7FFFFFFF
016	TCP Tell Captured Position 8	INTEGER32	RO/RO/RO	no	0x00	0x80000000	0x7FFFFFFF
017	TH Tell Reference State	INTEGER32	RO/RO/RO	no	0x00	0x80000000	0x7FFFFFFF
018	VER Version of Firmware	INTEGER32	RO/RO/RO	no	0x00	0x80000000	0x7FFFFFFF
019	ACV Acceleration Variation (Jerk, scaled to 1000)	INTEGER32	RO/RO/RO	no	0x00	0x80000000	0x7FFFFFFF
020	I2TM Limit Value (scaled to 10)	INTEGER32	RO/RO/RO	no	0x00	0x80000000	0x7FFFFFFF
021	I2T Calculated Value (scaled to 10)	INTEGER32	RO/RO/RO	no	0x00	0x80000000	0x7FFFFFFF
022	IFPK I_Force Peak (FTM = 0) FPK Force Peak (FTM = 1,2)	INTEGER32	RO/RO/RO	no	0x00	0x80000000	0x7FFFFFFF
023	TESM Tell SMU Error	INTEGER32	RO/RO/RO	no	0x00	0x80000000	0x7FFFFFFF
024	DGMSO Detected Gantry Master Slave Offset	INTEGER32	RO/RO/RO	no	0x00	0x80000000	0x7FFFFFFF
025	SIFF Sector I_Force Curve Failed (FTM = 0) SFF Sector Force Curve Failed (FTM = 1,2) (binary notation, LSB = sector 1)	INTEGER32	RO/RO/RO	no	0x00	0x80000000	0x7FFFFFFF
026	IFPKn I_Force Peak Sector (FTM = 0) FPKn Force Peak Sector (FTM = 1,2) (select sector over Object 0x5003/050)	INTEGER32	RO/RO/RO	no	0x00	0x80000000	0x7FFFFFFF
027	FCV Force Calibration Valid	INTEGER32	RO/RO/RO	no	0x00	0x80000000	0x7FFFFFFF
028	TV Tell Velocity	INTEGER32	RO/RO/RO	no	0x00	0x80000000	0x7FFFFFFF
029	TPT Tell Process Time	INTEGER32	RO/RO/RO	no	0x00	0x80000000	0x7FFFFFFF
030	VERL Version of Bootloader	INTEGER32	RO/RO/RO	no	0x00	0x80000000	0x7FFFFFFF
031	TCPB Tell Capture Pos. Buffer 1	INTEGER32	RO/RO/RO	no	0x00	0x80000000	0x7FFFFFFF
032	TCPB Tell Capture Pos. Buffer 2	INTEGER32	RO/RO/RO	no	0x00	0x80000000	0x7FFFFFFF
033	TCPB Tell Capture Pos. Buffer 3	INTEGER32	RO/RO/RO	no	0x00	0x80000000	0x7FFFFFFF
034	TCPB Tell Capture Pos. Buffer 4	INTEGER32	RO/RO/RO	no	0x00	0x80000000	0x7FFFFFFF
035	TCPB Tell Capture Pos. Buffer 5	INTEGER32	RO/RO/RO	no	0x00	0x80000000	0x7FFFFFFF
036	TCPB Tell Capture Pos. Buffer 6	INTEGER32	RO/RO/RO	no	0x00	0x80000000	0x7FFFFFFF
037	TCPB Tell Capture Pos. Buffer 7	INTEGER32	RO/RO/RO	no	0x00	0x80000000	0x7FFFFFFF
038	TCPB Tell Capture Pos. Buffer 8	INTEGER32	RO/RO/RO	no	0x00	0x80000000	0x7FFFFFFF
039	TESMH Tell SMU Error History	INTEGER32	RO/RO/RO	no	0x00	0x80000000	0x7FFFFFFF
040	GR Gear Ratio	INTEGER32	RO/RO/RO	no	0x00	0x80000000	0x7FFFFFFF
041	TTPS Tell Temperature Power Stage (Xvi75V8S only)	INTEGER32	RO/RO/RO	no	0x00	0x80000000	0x7FFFFFFF
042	TVPSM Tell voltage power supply motor in [mV]	INTEGER32	RO/RO/RO	no	0x00	0x80000000	0x7FFFFFFF

043	LARES linear axis resolution in [inc/m]	INTEGER32	RO/RO/RO	no	0x00	0x80000000	0x7FFFFFFF
044	LAST linear axis stroke in [inc]	INTEGER32	RO/RO/RO	no	0x00	0x80000000	0x7FFFFFFF

3.4.3 Write Parameter, XENAX®, 5002h

The Sub-indexes represent the specific parameter.

Sub-index	Description	Data Type	Access PreOp/SafeOp/Op	PDO Map	Default Value	Lower Limit	Upper Limit
000	NumOfEntries	INTEGER32	RO/RO/RO	no	0x10	0x0	0xFFFFFFFF
001	CO Clear Output Number	INTEGER32	WO/WO/WO	no	-	0x1	0x8
002	EVT Event Activation	INTEGER32	WO/WO/WO	no	0x0	0x0	0x1
003	G Go Immediately	INTEGER32	WO/WO/WO	no	-	0x80000000	0x7FFFFFFF
004	IX Start Index Number	INTEGER32	WO/WO/WO	no	-	0x1	0x32
005	PG Start Program Number	INTEGER32	WO/WO/WO	no	-	0x1	0x3F
006	SO Set Output Number	INTEGER32	WO/WO/WO	no	-	0x1	0x8
007	SOX Set Output Hex Mask	INTEGER32	WO/WO/WO	no	-	0x0	0xFF
008	TGD Set Trigger Position Downward	INTEGER32	WO/WO/WO	no	-	0x88CA6C00	0x77359400
009	TGU Set Trigger Position Upward	INTEGER32	WO/WO/WO	no	-	0x88CA6C00	0x77359400
010	ETI Enable Track Input	INTEGER32	WO/WO/WO	no	-	0x0	0xC
011	DTI Disable Track Input	INTEGER32	WO/WO/WO	no	-	0x0	0xC
012	PRF Start Profile Number	INTEGER32	WO/WO/WO	no	-	0x1	0x5
013	CRDA Cogging Reference Drive Automatic	INTEGER32	WO/WO/WO	no	-	0x0	0x7FFFFFFF
014	DIF Drive I_Force	INTEGER32	WO/WO/WO	no	-	0x1	0xA
015	CLIF Change Limit I_Force	INTEGER32	WO/WO/WO	no	-	0x0	0x7D0
016	DF Drive Force (Xvi75V8S only)	INTEGER32	WO/WO/WO	No	-	0x1	0x10

3.4.4 Read / Write Parameter XENAX®, 5003h

The Sub-indexes represent the specific parameter.

Sub-index	Description	Data Type	Access PreOp/SafeOp/Op	PDO Map	Default Value	Lower Limit	Upper Limit
000	NumOfEntries	INTEGER32	RO/RO/RO	no	0x5E	0x00	0xFFFFFFFF
001	AC Acceleration	INTEGER32	RW/RW/RW	no	0xF4240	0x7D0	0x3B9ACA00
002	S-Curve Profile (in percent)	INTEGER32	RW/RW/RW	no	0x14	0x01	0x64
003	SP Speed	INTEGER32	RW/RW/RW	no	0x186A0	0xA	0x5F5E100
004	PO Position (absolute)	INTEGER32	RW/RW/RW	no	0x0	0x88CA6C00	0x77359400
005	WA Way (relative)	INTEGER32	RW/RW/RW	no	0x4E20	0x88CA6C00	0x77359400
006	DP Deviation Position	INTEGER32	RW/RW/RW	no	0x7D0	0x1	0xF4240
007	DRHR Direction Reference	INTEGER32	RW/RW/RW	no	0x0	0x0	0x5
008	DTP Deviation Target Position	INTEGER32	RW/RW/RW	no	0x64	0x1	0x2710
009	ED Emergency Deceleration	INTEGER32	RW/RW/RW	no	0x989680	0x2710	0x3B9ACA00
010	ILAS Input Low Active Selective	INTEGER32	RW/RW/RW	no	0x0	0x0	0xFFF
011	ILA Input Low Active	INTEGER32	RW/RW/RW	no	0x0	0x0	0x2
012	IS Stop Current (Linear) Nominal Current (Rotative) scaled to 10mA	INTEGER32	RW/RW/RW	no	-	0xA	0x7D0
013	SLPP Software Limit Position Positive	INTEGER32	RW/RW/RW	no	0x0	0x80000000	0x7FFFFFFF
014	SLPN Software Limit Position Negative	INTEGER32	RW/RW/RW	no	0x0	0x80000000	0x7FFFFFFF
015	MD Mode	INTEGER32	RW/RW/RW	no	0x0	0x0	0xD
016	ML Mass Load (WebMotion: Payload / Inertia)	INTEGER32	RW/RW/RW	no	0x0	0x0	0x5F5E100
017	BWC Bandwidth Current Controller (WebMotion: GAIN CUR)	INTEGER32	RW/RW/RW	no	0x5DC	0x5	0x1388
018	BWP Bandwidth Position Controller (WebMotion: GAIN POS)	INTEGER32	RW/RW/RW	no	0x32	0x1	0x1388

Sub-index	Description	Data Type	Access PreOp/SafeOp/Op	PDO Map	Default Value	Lower Limit	Upper Limit
019	IR Run Current (Linear) Torque Current (Rotative) scaled to 10mA	INTEGER32	RW/RW/RW	no	0x4B0	0xA	0x7D0
020	NIX Preselected Index Number	INTEGER32	RW/RW/RW	no	-	0x1	0x32
021	AIX Acceleration of selected Index	INTEGER32	RW/RW/RW	no	0x3E8	0x2	0xF4240
022	SIX Speed of selected Index	INTEGER32	RW/RW/RW	no	0x186A0	0xA	0x5F5E100
023	DIX Distance of selected Index (depends on absolute or relative index definition)	INTEGER32	RW/RW/RW	no	0x0	0x88CA6C00	0x77359400
024	CI Card Identifier	INTEGER32	RW/RW/RW	no	0x0	0x0	0xFF
025	GSID Gantry Slave Identifier	INTEGER32	RW/RW/RW	no	0x0	0x0	0x4
026	FQC Filter Quality Current	INTEGER32	RW/RW/RW	no	0x1388	0x1F4	0x186A0
027	FFC Filter Frequency Current	INTEGER32	RW/RW/RW	no	0x0	0x0	0x7D0
028	ICP Increments per Puls	INTEGER32	RW/RW/RW	no	0x0	0x0	0x32
029	INH Input Home Sensor	INTEGER32	RW/RW/RW	no	0x1	0x1	0x8
030	OVRD Speed Override	INTEGER32	RW/RW/RW	no	0x64	0x0	0x64
031	PWRT Phasing Rotative w/o HALL	INTEGER32	RW/RW/RW	no	0x0	0x0	0x1
032	SOA Set Output Activity	INTEGER32	RW/RW/RW	no	0xFF	0x0	0xFF
033	SOT Set Output Type	INTEGER32	RW/RW/RW	no	0x5555	0x0	0xFFFF
034	SR Synchronous Ratio	INTEGER32	RW/RW/RW	no	0x0	0xFFFFFC18	0x3E8
035	CAB CAN Baud Rate	INTEGER32	R/R/R	no	0x7A120	0x2710	0xF4240
036	ROID Rotative Motor Identifier	INTEGER32	R/R/R	no	0x0	0x0	0x7FFFFFFF
037	Reserved	INTEGER32	RW/RW/RW	no	0x0	0x0	0x7FFFFFFF
038	Reserved	INTEGER32	RW/RW/RW	no	0x0	0x80000000	0x7FFFFFFF
039	SIFS Sector I_Force Start (FTM = 0) SFS Sector Force Start (FTM = 1,2)	INTEGER32	RW/RW/RW	no	0x0	0x88CA6C00	0x77359400
040	SIFE Sector I_Force End (FTM = 0) SFE Sectir Force End (FTM = 1,2)	INTEGER32	RW/RW/RW	no	0x0	0x88CA6C00	0x77359400
041	IFL I_Force Low	INTEGER32	RW/RW/RW	no	0x0	0xFFFFF6F8	0x7D0
042	IFH I_Force High	INTEGER32	RW/RW/RW	no	0x0	0xFFFFF6F8	0x7D0
043	MLPN Mechanical Limit Position Negative	INTEGER32	RW/RW/RW	no	0x0	0x80000000	0x7FFFFFFF
044	MLPP Mechanical Limit Positon Positive	INTEGER32	RW/RW/RW	no	0x0	0x80000000	0x7FFFFFFF
045	PGMSO Preset Gantry Master Slave Offset	INTEGER32	RW/RW/RW	no	0x0	0x88CA6C00	0x77359400
046	BRKD Brake delay	INTEGER32	RW/RW/RW	no	0x64	0x1	0x3E8
047	Reserved	INTEGER32	RW/RW/RW	no	0x0	0x0	0x2
048	LIF Limit I_Force	INTEGER32	RW/RW/RW	no	0x0	0x0	0x7D0
049	TYIX Type of Index	INTEGER32	RW/RW/RW	no	0x1	0x1	0x2
050	NSEC Preselected Sector Number	INTEGER32	RW/RW/RW	no	0x1	0x1	0xA
051	STCX Sector Transition Configuration (Hex Mask)	INTEGER32	RW/RW/RW	no	0x0	0x0	0xFFFF
052	NDIF Preselected Drive I_Force Number (FTM = 0) NDF Preselected Drive Force Number (FTM = 1,2)	INTEGER32	RW/RW/RW	no	0x1	0x1	0xA
053	ADIF Acceleration of selected Drive I_Force (FTM = 0) ADF Acceleration of selected Drive Force (FTM = 1,2)	INTEGER32	RW/RW/RW	no	0x3E8	0x2	0xF4240
054	SDIF Speed of selected Drive I_Force (FTM = 0) SDF Speed of selected Drive Force (FTM = 1,2)	INTEGER32	RW/RW/RW	no	0x186A0	0xA	0x5F5E100
055	IDIF I_Force Limit of selected Drive I_Force	INTEGER32	RW/RW/RW	no	0x1	0x1	0x7D0

Sub-index	Description	Data Type	Access PreOp/SafeOp/Op	PDO Map	Default Value	Lower Limit	Upper Limit
056	DDIF Direction of selected Drive I_Force (FTM = 0) DDF Direction of selected Drive Force (FTM = 1,2)	INTEGER32	RW/RW/RW	no	0x0	0x0	0x1
057	SSEC Select Sectors (binary notation, LSB = sector 1)	INTEGER32	RW/RW/RW	no	0x1	0x0	0x3FF
058	SSO Set Sector Offset	INTEGER32	RW/RW/RW	no	0x0	0x80000000	0x7FFFFFFF
059	ENCPD Encoder Plausibility Checking Disable	INTEGER32	RW/RW/RW	no	0x0	0x0	0x1
060	SPAD Set Point ACK disable	INTEGER32	RW/RW/RW	no	0x0	0x0	0x1
061	RXZP ROTAX® Z-Position	INTEGER32	RW/RW/RW	no	0x0	0x0	0x0
062	DRH Dir Home	INTEGER32	RW/RW/RW	no	0x1	0x1	0x2
063	DRZ Z-Mark	INTEGER32	RW/RW/RW	no	0x1	0x1	0x3
064	FQS Filter Quality Speed	INTEGER32	RW/RW/RW	no	0x1388	0x1F4	0x186A0
065	FFS Filter Frequency Speed	INTEGER32	RW/RW/RW	no	0x0	0x0	0x7D0
066	EBMD Enhanced Bandwidth Mode Disabled	INTEGER32	RW/RW/RW	no	0x0	0x0	0x1
067	Reserved	INTEGER32	RW/RW/RW	no	0x0	0x0	0x3E8
068	AIXD Acceleration of dynamically selected Index	INTEGER32	RW/RW/RW	no	0x3E8	0x2	0xF4240
069	SIXD Speed of dynamically selected Index	INTEGER32	RW/RW/RW	no	0x186A0	0xA	0x5F5E100
070	DIXD Distance of dynamically selected Index (depends on absolute or relative index definition)	INTEGER32	RW/RW/RW	no	0x0	0x88CA6C00	0x77359400
071	TYIXD Type of dynamically selected Index	INTEGER32	RW/RW/RW	no	0x1	0x1	0x2
072	PPSD Pole Placement Stability Dynamics	INTEGER32	RW/RW/RW	no	0x0	0xFFFFFFFFCE	0x32
073	IFDCS I_Force Drift Compensation Setting	INTEGER32	RW/RW/RW	no	0x3	0x0	0x7
074	Reserved	INTEGER32	RW/RW/RW	no	0x0	0x80000000	0x7FFFFFFF
075	SORF Swing Out Reduction Frequency	INTEGER32	RW/RW/RW	no	0x0	0x0	0x3E8
076	SORD Swing Out Reduction Damping	INTEGER32	RW/RW/RW	no	0x0	0x0	0x32
077	Reserved	INTEGER32	RW/RW/RW	no	0x0	0x0	0x1
078	Reserved	INTEGER32	RW/RW/RW	no	0x0	0x0	0x1
079	AVF Filter Frequency for Current Shaper	INTEGER32	RW/RW/RW	no	0x0	0x0	0x7D0
080	AVD Damping Ratio for Current Shaper	INTEGER32	RW/RW/RW	no	0x1	0x1	0x32
081	NOF Preselected Output Function	INTEGER32	RW/RW/RW	no	0x1	0x1	0x8
082	TYOF Type of Output Function	INTEGER32	RW/RW/RW	no	0x0	0x0	0xD
083	NIF Preselected Input Function	INTEGER32	RW/RW/RW	no	0x1	0x1	0x8
084	TYIF Type of Input Function	INTEGER32	RW/RW/RW	no	0x0	0x0	0x16
085	PAIF Parameter A of Input Function	INTEGER32	RW/RW/RW	no	0x0	0x80000000	0x7FFFFFFF
086	PBIF Parameter B of Input Function	INTEGER32	RW/RW/RW	no	0x0	0x80000000	0x7FFFFFFF
087	PCIF Parameter C of Input Function	INTEGER32	RW/RW/RW	no	0x0	0x80000000	0x7FFFFFFF
088	CLF Change Limit Force (Xvi75V8S only)	INTEGER32	RW/RW/RW	no	0x0	0x80000000	0x7FFFFFFF
089	FD Force of selected Drive Force (Xvi75V8S only)	INTEGER32	RW/RW/RW	no	0x0	0x80000000	0x7FFFFFFF
090	FH Force High (Xvi75V8S only)	INTEGER32	RW/RW/RW	no	0x0	0x80000000	0x7FFFFFFF
091	FL Force Low (Xvi75V8S only)	INTEGER32	RW/RW/RW	no	0x0	0x80000000	0x7FFFFFFF
092	FTM Forceteq® Mode (Xvi75V8S only)	INTEGER32	RW/RW/RW	no	0x0	0x0	0x2
093	SQBW Signateq® Bandwidth (Xvi75V8S only)	INTEGER32	RW/RW/RW	no	0x1F4	0x64	0x1388
094	MM Motor Manufacturer (Xvi75V8S only)	INTEGER32	RW/RW/RW	no	0x0	0x0	0x2
095	AREF Automatic Reference	INTEGER32	RW/RW/RW	no	0x0	0x0	0x1
096	EGMSO Enable user defined gantry Master/Slave offset	INTEGER32	RW/RW/RW	no	0x0	0x0	0x1

097	VMTAE Virtual multiturn for rotative motors with absolute encoder	INTEGER32	RW/RW/RW	no	0x0	0x0	0x7FFFFFFF
098	ENAR Enable absolute reference	INTEGER32	RW/RW/RW	no	0x0	0x0	0x1
099	CTAB Correction Table State	INTEGER32	RW/RW/RW	no	0x0	0x0	0x1
100	APSN number of program to auto start	INTEGER32	RW/RW/RW	no	0x0	0x0	0x3F
101	APSD Automatic program start delay[ms]	INTEGER32	RW/RW/RW	no	0x0	0x0	0xFFFF

3.4.5 Motor Parameter XENAX®, 5004h

The Sub-indexes represent the specific parameter.

Sub-index	Description	Data Type	Access (PreOp/SafeOp/Op)	PDO Map	Default Value	Lower Limit	Upper Limit
000	NumOfEntries	INTEGER32	RO/RO/RO	no	0xB	0x00	0xFFFFFFFF
001	POL Pole Pairs	INTEGER32	RW/RW/RW	no	0x0	0x0	0x64
002	ENC Encoder Increments (Rotative, 1 turn of motor shaft)	INTEGER32	RW/RW/RW	no	0x5DC0	0xA	0x989680
003	PHD Phase Direction	INTEGER32	RW/RW/RW	no	0x0	0x0	0x1
004	PHO Phase Offset	INTEGER32	RW/RW/RW	no	0x0	0x0	0x167
005	MAMO Slider Mass (LINAX® / ELAX®) Rotor Inertia (Rotative)	INTEGER32	RW/RW/RW	no	-	0x0	0x989680
006	FCM Force Constant of Motor	INTEGER32	RW/RW/RW	no	-	0x0	0x5F5E100
007	LPH Inductance Phase-Phase	INTEGER32	RW/RW/RW	no	-	0x0	0x186A0
008	RPH Resistance Phase-Phase	INTEGER32	RW/RW/RW	no	-	0x0	0x186A0
009	FFDY Frictional Force Dynamic	INTEGER32	RW/RW/RW	no	-	0x0	0x2710
010	FFST Frictional Force Static	INTEGER32	RW/RW/RW	no	-	0x0	0x2710
011	DMLPP Detected Mechanical Limit Position Positive	INTEGER32	RW/RW/RW	no	0x0	0x0	0x7FFFFFFF

3.4.6 SMU Parameter XENAX®, 5005h

The Sub-indexes represent the specific parameter.
These parameters are only accessible on a XENAX® with SMU support.

Sub-index	Description	Data Type	Access (PreOp/SafeOp/Op)	PDO Map	Default Value	Lower Limit	Upper Limit
000	NumOfEntries	INTEGER32	RO/RO/RO	no	0x0B	0x0	0xFFFFFFFF
001	VERS Version SMU*	INTEGER32	RO/RO/RO	no	0x00	0x80000000	0x7FFFFFFF
002	SLS Timeout	INTEGER32	RO/RO/RO	no	0x00	0x80000000	0x7FFFFFFF
003	Speed Limit	INTEGER32	RO/RO/RO	no	0x00	0x80000000	0x7FFFFFFF
004	Stop Timeout	INTEGER32	RO/RO/RO	no	0x00	0x80000000	0x7FFFFFFF
005	Position Window	INTEGER32	RO/RO/RO	no	0x00	0x80000000	0x7FFFFFFF
006	SFTRD Input Configuration SMU**	INTEGER32	RO/RO/RO	no	0x00	0x80000000	0x7FFFFFFF
007	TESM Tell SMU Error	INTEGER32	RO/RO/RO	no	0x00	0x80000000	0x7FFFFFFF
008	SMU Master Error Bitfeld***	INTEGER32	RO/RO/RO	no	0x00	0x80000000	0x7FFFFFFF
009	SMU Slave Error Bitfeld***	INTEGER32	RO/RO/RO	no	0x00	0x80000000	0x7FFFFFFF
010	SMU Master Info Bitfeld***	INTEGER32	RO/RO/RO	no	0x00	0x80000000	0x7FFFFFFF
011	SMU Slave Info Bitfeld***	INTEGER32	RO/RO/RO	no	0x00	0x80000000	0x7FFFFFFF
012	SPC Safety Parameter CRC	INTEGER32	RO/RO/RO	no	0x00	0x80000000	0x7FFFFFFF
013	SPCMAC Safety Parameter and MAC Adress CRC (Xvi75V8S only)	INTEGER32	RO/RO/RO	no	0x00	0x80000000	0x7FFFFFFF

* Byte 2-3 SMU Version, Byte 0-1 SMU Firmware CRC

** Each byte represents two Inputs:

SMU Function

Value 1 => STO

Value 2 => SS1

Value 3 => SS2

Value 4 => SLS

*** Contact Jenny Science for more Information

3.4.7 XENAX® Xvi75V8S and Xvi48V8 Parameter, 5006h

The Sub-indexes represent the specific parameter.
 These parameters are only accessible on XENAX® Xvi75V8S
 and on XENAX® Xvi48V8.

Sub-index	Description	Data Type	Access (PreOp/ SafeOp/Op)	PDO Map	Default Value	Lower Limit	Upper Limit
000	NumOfEntries	INTEGER32	RO/RO/RO	no	0xA	0x0	0xFFFFFFFF
001	EGW Set Gateway Address	INTEGER32	RW/RW/RW	no	0xCOA80201	0x80000000	0x7FFFFFFF
002	EIP Set IP Address	INTEGER32	RW/RW/RW	no	0xCOA80264	0x80000000	0x7FFFFFFF
003	ENM Set Net Mask	INTEGER32	RW/RW/RW	no	0xFFFFFFFFC00	0x80000000	0x7FFFFFFF
004	EMAC Read MAC Address 3 high Bytes	INTEGER32	RO/RO/RO	no	0x0	0x80000000	0x7FFFFFFF
005	EMAC Read MAC Address 3 low Bytes	INTEGER32	RO/RO/RO	no	0x0	0x80000000	0x7FFFFFFF
006	EPRT Set Port Number	INTEGER32	RW/RW/RW	no	0x2711	0x1	0x0000FFFF
007	LICR Show Installed Licences	INTEGER32	RO/RO/RO	no	0x0	0x80000000	0x7FFFFFFF
008	SERB Set Baud Rate on Serial Interface	INTEGER32	RW/RW/RW	no	0x1C200	0x2580	0x54600
009	WebMotion Version*	INTEGER32	RO/RO/RO	no	0x0	0x80000000	0x7FFFFFFF
010	WebMotion Boot Version*	INTEGER32	RO/RO/RO	no	0x0	0x80000000	0x7FFFFFFF

* Each Byte represents one character.

3.4.8 Forceteq pro Parameter, 5010h

The Sub-indexes represent the specific parameter.
 These parameters are only accessible on XENAX® Xvi75V8S
 with Signateq®.

Sub-index	Description	Data Type	Access (PreOp/ SafeOp/Op)	PDO Map	Default Value	Lower Limit	Upper Limit
000	NumOfEntries	INTEGER32	RO/RO/RO	no	0xC	0x0	0xFFFFFFFF
001	SQVER Signateq Firmware Version	INTEGER32	RO/RO/RO	no	0x0	0x80000000	0x7FFFFFFF
002	SQBW Signateq Bandwith	INTEGER32	RW/RW/RW	no	0x1F4	0x64	0x1388
003	SQSNF Signateq Sensor Nominal Force	INTEGER32	RW/RW/RW	no	0x0	0x0	0x30D40
004	SQMRP Signateq Measurement Range	INTEGER32	RW/RW/RW	no	0x0	0x0	0x30D40
005	Reserved	INTEGER32	RW/RW/RW	no	0x0	0x0	0x1
006	SQSS Signateq Sensor Sensitivity	INTEGER32	RW/RW/RW	no	0x0	0x0	0x17D7840
007	SQSFT Signateq Sensor Force Type	INTEGER32	RW/RW/RW	no	0x0	0x0	0x2
008	SQCM Signateq Calibration Mode	INTEGER32	RW/RW/RW	no	0x0	0x0	0x2
009	SQFD Signateq Force Direction	INTEGER32	RW/RW/RW	no	0x0	0x0	0x2
010	LFRMS Limit Force Reached Maximum Speed	INTEGER32	RW/RW/RW	no	0x0	0x0	0x895440
011	CLFO Clear force offset	INTEGER32	RW/RW/RW	no	0x0	0x0	0x1
012	SQAC Signateq available calibrations	INTEGER32	RO/RO/RO	no	0x0	0x0	0x7
013	BWFP Bandwidth for forceteq pro controller	INTEGER32	RW/RW/RW	no	0x32	0x1	0x3E8
014	FTPES Forceteq Pro Elastic Spring Constant	INTEGER32	RW/RW/RW	no	0x3E8	0x1	0x989680

3.4.9 Signateq Sensor Model Type (SQSMT), 5011h

DataType	Access (PreOp/SafeOp/Op)	PDO Mapping	Default Value	Lower Limit	Upper Limit
VISIBLE_STRING (30)	RW/RW/RW	no	None	-	-

3.4.10 Signateq Sensor Serial Number (SQSSN), 5012h

DataType	Access (PreOp/SafeOp/Op)	PDO Mapping	Default Value	Lower Limit	Upper Limit
VISIBLE_STRING (30)	RW/RW/RW	no	None	-	-

3.4.11 Tell Error String to the current Error (TES), 5020h

DataType	Access (PreOp/SafeOp/Op)	PDO Mapping	Default Value	Lower Limit	Upper Limit
VISIBLE_STRING (100)	RO/RO/RO	no	"no error"	-	-

3.4.12 Set servo identification string (SID), 5021h

DataType	Access (PreOp/SafeOp/Op)	PDO Mapping	Default Value	Lower Limit	Upper Limit
VISIBLE_STRING (32)	RW/RW/RW	no	" "	-	-

4 CANopen motion control DS402

4.1 State machine

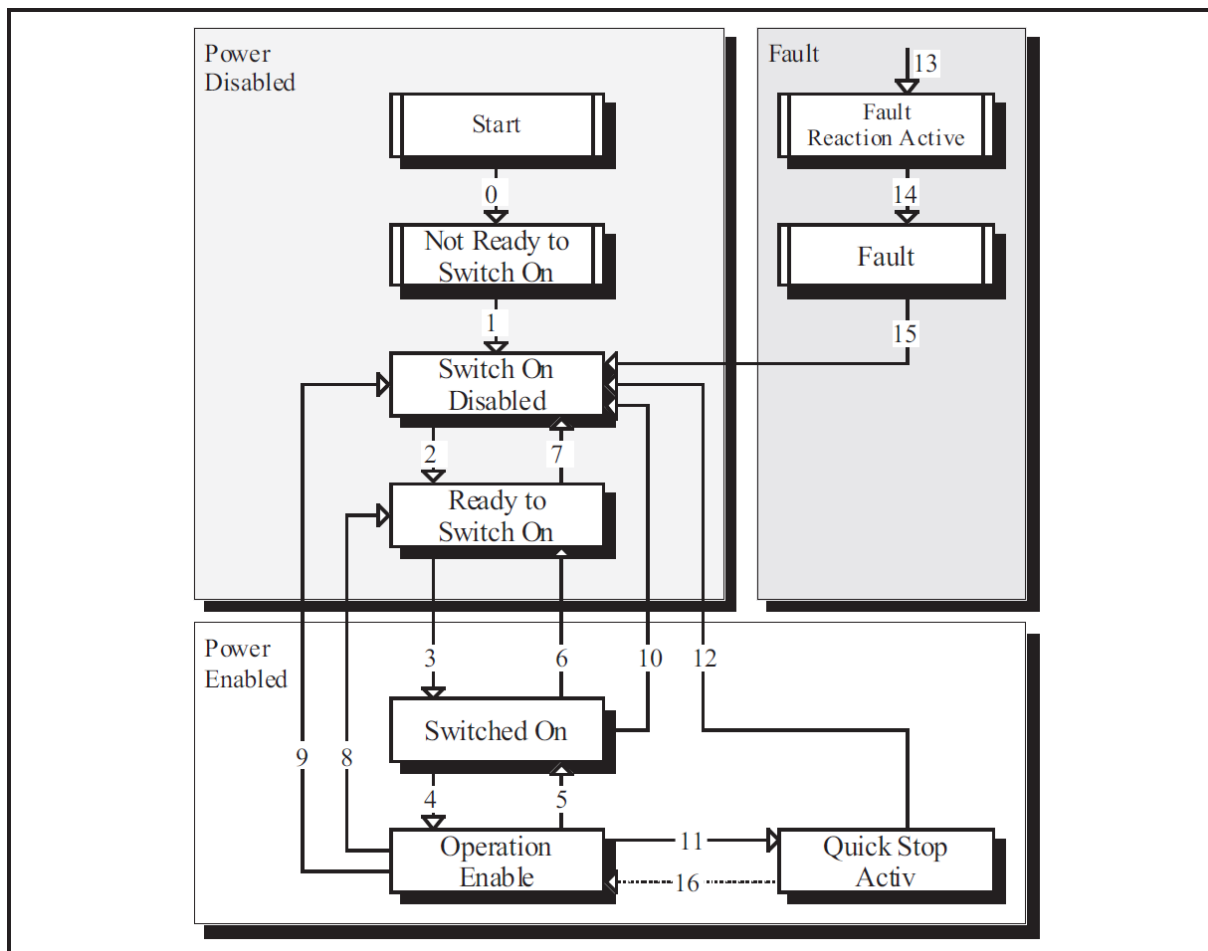

Transition	Event(s)	Action(s)
0	Automatic transition after power-on or reset application	Drive device self-test and/or self initialisation shall be performed.
1	Automatic transition	Communication shall be activated.
2	Shutdown command from control device or local signal	None
3	Switch on command received from control device or local signal	The high-level power shall be switched on, if possible.
4	Enable operation command received from control device or local signal	The drive function shall be enabled and all internal set-points cleared.
5	Disable operation command received from control device or local signal	The drive function shall be disabled.
6	Shutdown command received from control device or local signal	The high-level power shall be switched off, if possible.
7	Quick stop or disable voltage command from control device or local signal	None
8	Shutdown command from control device or local signal	The drive function shall be disabled, and the high-level power shall be switched off, if possible.
9	Disable voltage command from control device or local signal	The drive function shall be disabled, and the high-level power shall be switched off, if possible.
10	Disable voltage or quick stop command from control device or local signal	The high-level power shall be switched off, if possible.
11	Quick stop command from control device or local signal	The quick stop function shall be started.
13	Fault signal (see also /CIA402-3/)	The configured fault reaction function shall be executed.
14	Automatic transition	The drive function shall be disabled; the high-level power shall be switched off, if possible.
15	Fault reset command from control device or local signal	A reset of the fault condition is carried out, if no fault exists currently on the drive device; after leaving the Fault state, the Fault reset bit in the controlword shall be cleared by the control device.
16	Enable operation command from control device, if the quick stop option code is 5, 6, 7, or 8	The drive function shall be enabled.

4.2 Objects device profile DS402

4.2.1 Error Code, 603Fh

Data Type	Access (PreOp/SafeOp/Op)	PDO Mapping	Default Value	Lower Limit	Upper Limit
Unsigned 16	RO/RO/RO	no	0x0000	0x0000	0xFFFF

This object contains the coded XENAX® error messages (for detailed explanations of the different error messages refer to object 2004h) as following:

0	No Error on XENAX® display
0xFF01..99	Info/Warning/Error 1 to 99 on XENAX® display

4.2.2 Controlword, 6040h

Data Type	Access (PreOp/SafeOp/Op)	PDO Mapping	Default Value	Lower Limit	Upper Limit
Unsigned 16	RW/RW/RW	RxPDO / TxPDO	0x0000	0x0000	0xFFFF

The object is organized bit-wise as follows:

Bit 0	switch on
Bit 1	enable voltage
Bit 2	quick stop (switch off power)
Bit 3	enable operation
Bit 4	Reference start (Reference mode) New Position (Profile position mode) Start Jog drive (Jog mode)
Bit 5	not used
Bit 6	(Profile position mode) 0: Absolute Position 1: Relative Distance (Jog mode) 0: Direction negative 1: Direction positive
Bit 7	fault reset
Bit 8	Halt (usable in motion only)
Bit 9	operation mode-specific
Bit 10	reserved
Bit 11-15	manufacturer-specific

Command	Bits of the controlword					Transitions
	Bit 7	Bit 3	Bit 2	Bit 1	Bit 0	
Shutdown	0	X	1	1	0	2,6,8
Switch on	0	0	1	1	1	3
Switch on + enable operation	0	1	1	1	1	3 + 4 (NOTE)
Disable voltage	0	X	X	0	X	7,9,10,12
Quick stop	0	X	0	1	X	7,10,11
Disable operation	0	0	1	1	1	5
Enable operation	0	1	1	1	1	4,16
Fault reset		X	X	X	X	15

NOTE Automatic transition to Enable operation state after executing SWITCHED ON state functionality.

4.2.3 Statusword, 6041h

DataType	Access (PreOp/SafeOp/Op)	PDO Mapping	Default Value	Lower Limit	Upper Limit
Unsigned 16	RO/RO/RO	TxPDO	0x0000	0x0000	0xFFFF

Bit 0	ready to switch on
Bit 1	switched on
Bit 2	operation enabled
Bit 3	fault
Bit 4	voltage enabled
Bit 5	quick stop
Bit 6	switch on disabled
Bit 7	warning
Bit 8	manufacturer-specific
Bit 9	remote
Bit 10	(Profile position mode) target position reached (Jog mode) constant speed reached (Reference mode) Reference performed
Bit 11	Soft-Limit position reached
Bit 12	(Profile position mode) Acknowledge of moving to target position (Cyclic Synchronous Position Mode) Target position used for control loop (Jog mode) Speed is equal 0 (Reference mode) Reference achieved
Bit 13	(Reference mode) Reference error
Bit 14-15	manufacturer-specific*

Statusword	PDS FSA state
xxxx xxxx x0xx 0000 _b	Not ready to switch on
xxxx xxxx x1xx 0000 _b	Switch on disabled
xxxx xxxx x01x 0001 _b	Ready to switch on
xxxx xxxx x01x 0011 _b	Switched on
xxxx xxxx x01x 0111 _b	Operation enabled
xxxx xxxx x00x 0111 _b	Quick stop active
xxxx xxxx x0xx 1111 _b	Fault reaction active
xxxx xxxx x0xx 1000 _b	Fault

4.2.4 Modes of Operation Requested, 6060h

This object contains the value of the requested operation mode.

The actual operation mode is shown in the object 6061

DataType	Access (PreOp/SafeOp/Op)	PDO Mapping	Default Value	Lower Limit	Upper Limit
Integer 8	RW/RW/RW	RxPDO / TxPDO	0x00	0xFE	0x0A

The following value definitions are valid:

-2	XENAX® specific, not used
-1	Jog mode Jenny Science specific
0	no mode change / no mode assigned
1	profile position mode
6	reference mode
8	cyclic synchronous position mode

4.2.5 Modes of Operation Display, 6061h

DataType	Access (PreOp/SafeOp/Op)	PDO Mapping	Default Value	Lower Limit	Upper Limit
Integer 8	RO/RO/RO	TxPDO	0x00	0xFE	0x0A

This object shows the actual operation mode.

-2	XENAX® specific, not used
-1	Jog mode Jenny Science specific
0	no mode change / no mode assigned
1	profile position mode
6	reference mode
8	cyclic synchronous position mode

4.2.6 Position Actual Value, 6064h

This object shows the actual absolute position value of XENAX® internal encoder counter in increments.

Data Type	Access (PreOp/SafeOp/Op)	PDO Mapping	Unit	Default Value	Lower Limit	Upper Limit
Integer 32	RO/RO/RO	TxPDO	measured Increments	0x0000	0x80000000	0x7FFFFFFF

4.2.7 Following Position Error Window, 6065h

The following position error window defines the range of tolerated position values symmetrical to the trajectory. If the actual position is out of range a following error (no 50) occurs.

A following error may occur when a motor is blocked (break on), or unreachable acceleration or speed parameters, or by wrong closed-loop parameters. After this following position error (no 50) occurs, it is not necessary to run the Reference again. Just use the command PWC, Object 5000h, value 2010h.

Data Type	Access (PreOp/SafeOp/Op)	PDO Mapping	Unit	Default Value	Lower Limit	Upper Limit
Unsigned 32	RW/RW/RW	RxPDO / TxPDO	measured Increments	0x7D0 (2000)	0x1	0xF4240 (1000000)

4.2.8 Target Position Window, 6067h

Set the tolerance +/- of position deviation corresponding to the target position. If the actual value of the position encoder is within the tolerance, the corresponding status bit says the target is reached. If the actual position is outside of the tolerance and above following position error is inside the window then the motor will try endless to go to the target position. For this case you need a program timeout sequence.

Data Type	Access (PreOp/SafeOp/Op)	PDO Mapping	Unit	Default Value	Lower Limit	Upper Limit
Unsigned 32	RW/RW/RW	RxPDO / TxPDO	measured Increments	0x64 (100)	0x1	0x2710 (10000)

4.2.9 Position Window Time (PWT), 6068h

This object indicates the dwell time of the actual position within the position window for the Statusword Bit "Target Position Reached".

Data Type	Access (PreOp/SafeOp/Op)	PDO Mapping	Unit	Default Value	Lower Limit	Upper Limit
Unsigned 16	RW/RW/RW	no	ms	0x0	0x0	0x3E8 (1000)

4.2.10 Velocity Actual Value, 606Ch

This object contains the value of the actual velocity of the axis in increments per s.

Data Type	Access (PreOp/SafeOp/Op)	PDO Mapping	Unit	Default Value	Lower Limit	Upper Limit
Integer 32	RO/RO/RO	TxPDO	Increments per second	0x00000000	0x80000000	0x7FFFFFFF

4.2.11 Limit I_Force, 6073h

This current corresponds to the force of linear motor or the torque of rotative motor. If Limit I_Force Value [x10mA] is set the I Stop and I Run is set to the Limit I_Force value.
For higher force accuracy with LINAX® linear motors run first the force calibration drive.
object 5000h, value 4000h

DataType	Access (PreOp/SafeOp/Op)	PDO Mapping	Unit	Default Value	Lower Limit	Upper Limit
Unsigned 16	RW/RW/RW	RxPDO / TxPDO	10 mA	0x0	0x0	0x7D0 (=> 20A)

4.2.12 Motor Current Actual Value, 6078h

This object shows the actual value of the motor current [mA]. This corresponds with the actual force or torque of the motor

DataType	Access (PreOp/SafeOp/Op)	PDO Mapping	Unit	Lower Limit	Upper Limit
Integer 16	RO/RO/RO	TxPDO	mA	0xB1E0 (-18000mA)	0x4E20 (18000mA)

4.2.13 Target Position/Distance, 607Ah

The value of this object is used as absolute position or relative distance depending on bit 6 of the Controlword 6060h. This object is used in profile position mode and also in cyclic synchronous position mode. In cyclic synchronous mode the value is the absolute position

DataType	Access (PreOp/SafeOp/Op)	PDO Mapping	Unit	Default Value	Lower Limit	Upper Limit
Integer 32	RW/RW/RW	RxPDO / TxPDO	measured Increments	0x00	0x80000000	0x7FFFFFFF

4.2.14 Soft-Limit Positions, 607Dh

These parameters define the Soft-Limit position absolute with linear axis left and right and rotative axis forward and backward
Every new target position shall be checked against these limits. The limit positions shall always correspond to the absolute position in the mechanical system.

Sub-index	Description	DataType	Access (PreOp/SafeOp/Op)	PDO Map	Unit	Default Value	Lower Limit	Upper Limit
000	Highest Sub-index Value	INTEGER32	RO/RO/RO	no	-	0x00000002	0x00000002	0x00000002
001	Software Position Limit Left	INTEGER32	RW/RW/RW	no	measured Increments	0x0	0x80000000	0x7FFFFFFF
002	Software Position Limit Right	INTEGER32	RW/RW/RW	no	measured Increments	0x0	0x80000000	0x7FFFFFFF

4.2.15 Speed, Jog or Profile Position Mode, 6081h

Data Type	Access (PreOp/ SafeOp/Op)	PDO Mapping	Unit	Default Value	Lower Limit	Upper Limit
Unsigned 32	RW/RW/RW	RxPDO / TxPDO	Increments per second	0x186A0	0xA	0x5F5E100

4.2.16 Acceleration, Jog or Profile Position Mode, 6083h

Data Type	Access (PreOp/ SafeOp/Op)	PDO Mapping	Unit	Default Value	Lower Limit	Upper Limit
Unsigned 32	RW/RW/RW	RxPDO / TxPDO	Increments per seconds ²	0xF4240	0x7D0	0x3B9ACA00

4.2.17 Deceleration, Jog or Profile Position Mode, 6084h

This parameter is not supported. Deceleration value is the same as acceleration value. With WebMotion it is possible to program flexible motion profiles with different accelerations, speeds and decelerations. Browser Navigation “profile”.

4.2.18 Deceleration, Quick Stop, 6085h

This fast deceleration is typically used to stop the motor in emergency situation. To do this, the quick stop bit in control word 6040h has to be activated.

Data Type	Access (PreOp/ SafeOp/Op)	PDO Mapping	Unit	Default Value	Lower Limit	Upper Limit
Unsigned 32	RW/RW/RW	no	Increments per second ²	0x989680	0x2710	0x3B9ACA00

4.2.19 Reference Methods, 6098h

The reference methods are divided in two separate procedures. For LINAX® linear motors with distance coded reference marks. The REFERENCE must be always the first initial function after power on, because it is used for precise adjustment of the electrical angle of the liner motor. For rotative motors with/without external REFERENCE sensor and with/without Z-mark on the encoder.

DataType	Access (PreOp/ SafeOp/Op)	PDO Mapping	Unit	Default Value	Lower Limit	Upper Limit
INTEGER8	RW/RW/RW	no	-	0x01	0x01	0x0F

LINAX® liner motor axes	
1	REFERENCE, start direction positive
2	REFERENCE, start direction negative
3	REFERENCE, gantry system, direction positive, linear motor axes same measurement system orientation
4	REFERENCE, gantry system, direction negative, linear motor axes same measurement system orientation
5	REFERENCE, gantry system, direction positive, linear motors axes contrary measurement system orientation
6	REFERENCE, gantry system, direction negative, linear motors axes contrary measurement system orientation

Rotative motors	
10	REFERENCE, start clockwise -> external reference Sensor, continue counter clockwise -> Z-mark
11	REFERENCE, start clockwise -> external reference Sensor, continue clockwise -> Z-mark
12	REFERENCE, start counter clockwise -> external reference Sensor, continue counter clockwise -> Z-mark
13	REFERENCE, start, counter clockwise -> external reference Sensor, continue clockwise -> Z-mark
14	REFERENCE, start clockwise -> external reference Sensor, shortest way -> Z-mark only for ROTAX® Rxvp
15	REFERENCE, start, counter clockwise -> external reference Sensor, shortest way -> Z-mark only for ROTAX® Rxvp

4.2.20 Reference Speeds, Rotative Motors 6099h

If there is no REFERENCE sensor, then set the reference Speed to 0.
 If there is no Z-mark on the encoder, then set the Z-Speed to 0.

Sub-index	Description	DataType	Access (PreOp/ SafeOp/Op)	PDO Mapping	Unit	Default Value	Lower Limit	Upper Limit
000	Highest Sub-index Value	Unsigned 32	RO/RO/RO	no	-	0x2	0x2	0x2
001	Reference-Speed searching external Reference sensor	Unsigned 32	RW/RW/RW	no	Increments per second	0x3E8	0x0	0x3D090
002	Z-Speed searching internal encoder Z-mark	Unsigned 32	RW/RW/RW	no	Increments per second	0x1F4	0x0	0x186A0

4.2.21 Reference Acceleration, 609Ah

This object contains the acceleration/deceleration value, used during reference operation. But this object is not supported. This reference acceleration/deceleration values corresponds to the acceleration value in object 6083h.

4.2.22 Velocity offset, Cyclic Sync Position Mode, 60B1h

This object is only used in cyclic sync position mode as velocity feed forward for XENAX internal trajectory calculator and can be used for enhanced trajectory calculation. The use of this object is not mandatory. If this object is not mapped to PDO, velocity is reconstructed in XENAX itself.

Data Type	Access (PreOp/ SafeOp/Op)	PDO Mapping	Unit	Default Value	Lower Limit	Upper Limit
Integer 32	RW/RW/RW	RxPDO / TxPDO	Increments per second	0x00	0xFF76ABC0 (-9'000'000)	0x895440 (9'000'000)

4.2.23 Torque Offset, Cyclic Sync Position Mode, 60B2h

This object is only used in cyclic sync position mode for acceleration feed forward calculation in XENAX internal trajectory calculator and can be used for enhanced trajectory calculation. The relation between transmitted torque offset (value of object 0x60B2) and internally used acceleration feed forward is as follows:

$$\text{Acceleration_Feed_Forward} = \text{0x60B2} * \text{Acceleration_Scaling}$$

with:

$$\text{Acceleration_Feed_Forward} = \text{acceleration in inc/s}^2$$

$$\text{0x60B2} = \text{Object "Torque Offset" in inc/s}^2 \text{ (scaled)}$$

$$\text{Acceleration_Scaling} = \text{Scaling factor for "Torque Offset"}$$

The factor Acceleration_Scaling is dependent on bus protocol setting:

$$\text{EtherCAT} \rightarrow \text{Acceleration_Scaling} = 50'000$$

$$\text{Other bus protocols} \rightarrow \text{Acceleration_Scaling} = 1$$

The use of this object is not mandatory. If this object is not mapped to PDO, acceleration is reconstructed in XENAX itself.

For the use of this object, it is mandatory to map as well object 0x60B1 "Velocity offset".

Data Type	Access (PreOp/ SafeOp/Op)	PDO Mapping	Unit	Default Value	Lower Limit	Upper Limit
Integer 16	RW/RW/RW	RxPDO / TxPDO	inc / s ² (scaled)	0x00	0x8000	0x7FFF

4.2.24 Synchronous Cycle Time, 60C2h

This object contains base and exponent values to calculate the cycle time. The cycle time is typically used in cyclic synchronous position mode to transfer the absolute position value in synchronous way. The XENAX® Xvi servocontroller automatically generate a linear interpolation of position value between the synchronous cycle time and his faster internal position-loop time.

Sub-Indexes:

Sub-Index 1: BASE

Sub-Index 2: 10^{EXPONENT}

Synchronous cycle Time in seconds = BASE x 10^{EXPONENT}

Example synchronous cycle time of 500µs:

Sub-Index 1 value: BASE = 5

Sub-Index 2 value: 10^{EXPONENT} = -4

Sub-index	Description	Data Type	Access(PreOp/SafeOp/Op)	PDO Mapping	Unit	Default Value	Lower Limit	Upper Limit
000	Highest Sub-index Value	P402_IP_PERIOD_T	RO/RO/RO	no	-	0x2	0x2	0x2
001	Base value	Unsigned 8	RW/RW/RW	no	-	0x01	0x0	0xFF
002	10 ^{EXPONENT}	INTEGER8	RW/RW/RW	no	-	0xFD	0x80	0x3F

4.2.25 Actual Position Following Error, 60F4h

The value is the actual deviation of calculated trajectory position and measured position on linear or rotative encoder.

Data Type	Access (PreOp/SafeOp/Op)	PDO Mapping	Unit	Lower Limit	Upper Limit
INTEGER32	RO/RO/RO	TxPDO	Increments	0x80000000	0x7FFFFFFF

4.2.26 Digital Inputs XENAX®, 60FDh

This object contains the status of digital inputs on the XENAX® servo controller.

Bit value = 0: input is Low
 Bit value = 1: input is High

(With the XENAX® WebMotion a set-up of Low active or High active Input function is possible)

Data Type	Access (PreOp/ SafeOp/Op)	PDO Mapping	Default Value	Lower Limit	Upper Limit
Unsigned 32	RO/RO/RO	TxPDO	0x00000000	0x00000000	0xFFFFFFFF

Bit 0	negative limit switch
Bit 1	positive limit switch
Bit 2	not used
Bit 3	interlock (EE/EE_1 Function)
Bit 16-27	digital inputs 1-12
Bit 28-31	not used

4.2.27 Digital Outputs XENAX®, 60FEh

Control the digital output signals of XENAX®

Sub-Index 1: for the physical output bit value
 Sub-Index 2: mask for the physical outputs (not supported)

Bit value = 0: output is logic 0
 Bit value = 1: output is logic 1

Default set-up, all Outputs: SOURCE and HIGH ACTIVE
 Logic 1 = 24V
 Logic 0 = open

The physical output level can be set-up for every output bit individual (Source, Sink, Source&Sink driver)
 See XENAX_Xvi75V8_MANUAL_E.pdf.

Sub-index	Description	Data Type	Access(PreOp/ SafeOp/Op)	PDO Mapping	Default Value	Lower Limit	Upper Limit
000	Highest Sub-index Value	Unsigned 32	RO/RO/RO	no	0x02	0x1	0x2
001	Output Bit	Unsigned 32	RW/RW/RW	RxPDO / TxPDO	0x0	0x0	0xFFFFFFFF
002	Output Mask (not supported)	Unsigned 32	RW/RW/RW	no	0x0	0x0	0xFFFFFFFF

Bit 0	set brake (not used)
Bit 16-23	digital outputs 1-8

4.2.28 Target Velocity, 60FFh

This object is only used in cyclic sync position mode as velocity feed forward for XENAX internal trajectory calculator and can be used for enhanced trajectory calculation. The use of this object is not mandatory. If this object is not mapped to PDO, velocity is reconstructed in XENAX itself.

Data Type	Access (PreOp/ SafeOp/Op)	PDO Mapping	Unit	Default Value	Lower Limit	Upper Limit
Integer 32	RW/RW/RW	RxPDO / TxPDO	Increments per second	0x00	0xFF76ABC0 (-9'000'000)	0x895440 (9'000'000)

4.2.29 Supported Modes of Operation, 6502h

The value shows the supported modes of Operation.
 Bit-wise orientated
 1 = Supported
 0 = Not supported

Data Type	Access (PreOp/ SafeOp/Op)	PDO Mapping	Default Value	Lower Limit	Upper Limit
Unsigned 32	RO/RO/RO	no	0x000100A1	0x000100A1	0x000100A1

Bit 0	profile position mode	1
Bit 1	speed mode	0
Bit 2	profile speed mode	0
Bit 3	profile torque mode	0
Bit 4	reserved	0
Bit 5	reference mode	1
Bit 6	interpolated position mode*	0*
Bit 7	cyclic synchronous position mode	1
Bit 8	cyclic synchronous speed mode	0
Bit 9	cyclic synchronous torque mode	0
Bit 10-15	reserved	0
Bit 16	Jog mode Jenny Science specific	1
Bit 17	reserved (Jenny Science specific)	0
Bit 18-31	manufacturer-specific	-

*) This interpolated position mode is supported with the cyclic synchronous position mode. Because with the cyclic synchronous position mode, the received position values (trajectory) are automatically linear interpolated between the lower cyclic synchronous time and the faster, internal positioning loop time of the XENAX®.

4.2.30 Product Website Address, 6505h

This object indicates the assigned web address of the drive manufacturer. If the address is not assigned yet, this object shall indicate this by /0 (empty string).

Data Type	Access (PreOp/ SafeOp/Op)	PDO Mapping	Default Value	Lower Limit	Upper Limit
VISIBLE_STRING	RO/RO/RO	no	http://www.jennyscience.ch	-	-

5 Modes of Operation

5.1 Reference Mode

Mode specific bits of the Controlword, 6040h

Bit 4	Reference operation start
-------	---------------------------

Mode specific bits of the Statusword, 6041h

Bit 12	Reference achieved
Bit 13	Reference error

5.1.1 Reference of LINAX® / ELAX® linear motor axes

With LINAX® / ELAX® linear motor axes the first start after power On, the Reference Mode must be done. Do REF also after logic power interruption. Otherwise the automatic adjustment of the electrical angle between magnets and coil poles will not be done.

If an error occurs i.e. 50 no REF is necessary, because with the logical power the position counter remains active. Use the command PWC, object 5000h, Sub-index 2010h to continue the process.

On the glass/magnet scale are distance coded reference marks. With a run over two reference marks the absolute position is calculated to the mechanical zero position. At this moment the calculated absolute position is in effect.

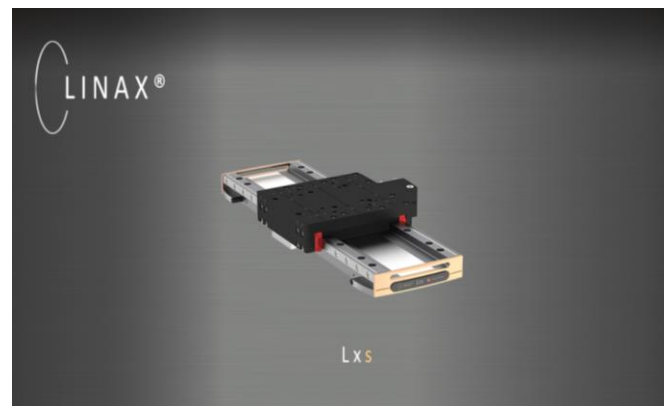

5.1.2 Example REFERENCE LINAX® single axes

Object	Description	Value	Activities
0x6060	Modes of Operation requested	0x06	Set Reference Mode
0x6061	Modes of Operation display		Wait until Reference Mode is active, Value = 0x06
0x6098	Reference method linear	0x ...	0x01 REFERENCE, start direction positive 0x02 REFERENCE, start direction negative
0x6040	Controlword	0x06	Switch to state "Ready to switch on"
0x6041	Statusword		Wait until state "Ready to switch on" is reached => Statusword = xxxx xxxx x01x 0001 _b
0x6040	Controlword	0x07	Switch to state "Switched on"
0x6041	Statusword		Wait until state "Switched on" is reached => Statusword = xxxx xxxx x01x 0011 _b
0x6040	Controlword	0x0F	Switch to state "Operation enable" -> Powerstage active
0x6041	Statusword		Wait until state "Operation enable" is reached => Statusword = xxxx xxxx x01x 0111 _b
0x6040	Controlword	0x1F	Reference operation starts
0x6041	Statusword		Wait until reference is finished => Bit 12 in Statusword (Reference achieved) is set
0x6060	Modes of operation requested	0x08 0x01	Set the mode of operation to the desired driving mode. 0x08 for cyclic synchronous position mode or 0x01 for profile position mode.
0x6061	Modes of operation display		Wait until Reference Mode equal to the requested mode.
Continue driving as specified in the DS402 standard.			

5.1.3 Reference of LINAX® gantry systems

Reference of a LINAX® gantry system is using the master-slave connection of the XENAX® Xvi servo controllers. The gantry initialization is a stand-alone process controlled by master XENAX®. After completion the reference, both servo controllers (axes) must be change to cyclic synchronous position mode, served with identical absolute position information.

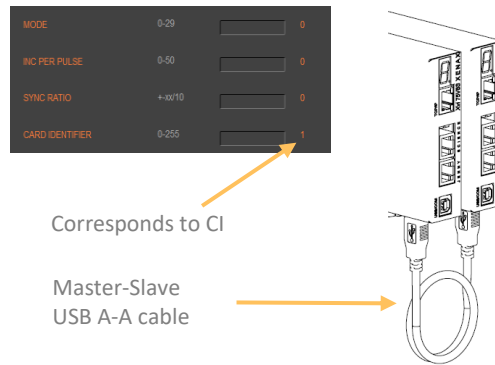
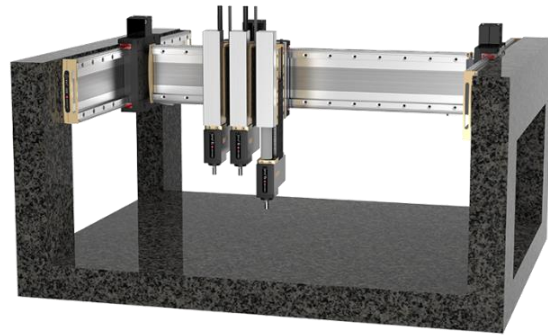

5.1.4 Example of Reference LINAX® gantry systems

Object	Description	Value	Activities
0x6060	Modes of Operation requested	0x06	Set Reference Mode
0x6061	Modes of Operation display		Wait until Reference Mode is active, Value = 0x06
0x6098	Reference method gantry	0x ...	Depending on mechanical fitting of the gantry axes 0x03 REF, gantry system, direction positive, linear motor axes same measurement system orientation 0x04 REF, gantry system, direction negative, linear motor axes same measurement system orientation 0x05 REF, gantry system, direction positive, linear motors axes contrary measurement system orientation 0x06 REF, gantry system, direction negative, linear motors axes contrary measurement system orientation
0x6040	Controlword	0x06	Ready to Switch on
0x6041	Statusword		Wait until state "Ready to switch on" is reached => Statusword = xxxx xxxx x01x 0001 _b
0x6040	Controlword	0x07	Switch to state "Switched on"
0x6041	Statusword		Wait until state "Switched on" is reached => Statusword = xxxx xxxx x01x 0011 _b
0x6040	Controlword	0x0F	Switch to state "Operation enable" -> Powerstage active
0x6041	Statusword		Wait until state "Operation enable" is reached => Statusword = xxxx xxxx x01x 0111 _b
0x6040	Controlword	0x1F	Reference operation starts
0x6041	Statusword		Wait until reference is finished => Bit 12 in Statusword (Reference achieved) is set
0x6060	Modes of operation requested	0x08 0x01	Set the mode of operation to the desired driving mode. 0x08 for cyclic synchronous position mode or 0x01 for profile position mode.
0x6061	Modes of operation display		Wait until Reference Mode equal to the requested mode.

Continue driving as specified in the DS402 standard.

5.1.5 Reference of rotative third party motors

In a typical configuration of rotative axis, there is an external REFERENCE sensor to find the mechanical reference range.
After lock for the precise reference position with the internal Z-mark on the encoder.



For an optimal function the motor should turn about a half revolution from the REFERENCE sensor to the Z-mark.

If the REFERENCE sensor and the Z-mark are close-by, there is no reliable function guaranteed.

This configuration is set-up by mechanical adjustment, fixation of motor shaft, positioning of reference sensor.

5.1.6 Example of Reference rotative third party motors

Object	Description	Value	Activities
0x6060	Modes of Operation requested	0x06	Set Reference Mode
0x6061	Modes of Operation display		Wait until Reference Mode is active, Value = 0x06
0x6098	Reference method rotative	0x ...	0x0A REFERENCE, start clockwise -> external reference Sensor, continue counter clockwise -> Z-mark 0x0B REFERENCE, start clockwise -> external reference Sensor, continue clockwise -> Z-mark 0x0C REFERENCE, start counter clockwise -> external reference Sensor, continue counter clockwise -> Z-mark 0x0D REFERENCE, start, counter clockwise -> external reference Sensor, continue clockwise -> Z-mark
0x6099, Sub-index 01	Reference -Speed for search the external reference sensor	Using 32	If there is no REFERENCE sensor, then set the reference Speed to 0
0x6099, Sub-index 02	Z-Speed for search the internal encoder Z-mark	Using 32	If there is no Z-mark on the encoder, then set the Z-Speed to 0
0x6040	Controlword	0x06	Ready to Switch on
0x6041	Statusword		Wait until state "Ready to switch on" is reached => Statusword = xxxx xxxx x01x 0001 _b
0x6040	Controlword	0x07	Switch to state "Switched on"
0x6041	Statusword		Wait until state "Switched on" is reached => Statusword = xxxx xxxx x01x 0011 _b
0x6040	Controlword	0x0F	Switch to state "Operation enable" -> Powerstage active
0x6041	Statusword		Wait until state "Operation enable" is reached => Statusword = xxxx xxxx x01x 0111 _b
0x6040	Controlword	0x1F	Reference operation starts
0x6041	Statusword		Wait until reference is finished => Bit 12 in Statusword (Reference achieved) is set
0x6060	Modes of operation requested	0x08 0x01 -0x01	Set the mode of operation to the desired driving mode. 0x08 for cyclic synchronous position mode, 0x01 for profile position mode or -0x01 for jog velocity.
0x6061	Modes of operation display		Wait until Reference Mode equal to the requested mode.

Continue driving as specified in the DS402 standard.

Notice:

To assign the external REFERENCE sensor to a physical Input, the Input number have to be programmed with WebMotion in menu *programming / reference function*

5.1.7 Reference of ROTAX® Rxvp rotary motor

There are two more reference methods with the ROTAX® rotary motor axes to reference with the internal Z-mark on the encoder:

0x0E REFERENCE, start, clockwise -> external reference Sensor, shortest way -> Z-mark

0x0F REFERENCE, start, counter clockwise -> external reference Sensor, shortest way -> Z-mark



Rxvp = vacuum pressure

5.1.8 Reference of ROTAX® Rxhq rotary motor

Due to the absolute position, the ROTAX® Rxhq is immediately ready for operation after power-on, no reference drive is necessary. For this purpose, the Z-MARK DIR must be set to 0 and the REF INPUT to NONE. The position of the encoder immediately after startup always has a value between 0 and 119'999Inc.



Rxhq = high torque

5.1.9 Example of Reset Reference Failure

Object	Description	Value	Activities
0x6040	Controlword	0x80	Fault reset
0x6041	Statusword		Wait until fault is reset => Bit 3 in Statusword (Fault) is cleared
0x6040	Controlword	0x06	Ready to Switch on
0x6041	Statusword		Wait until state "Ready to switch on" is reached => Statusword = xxxx xxxx x01x 0001 _b
0x6040	Controlword	0x07	Switch to state "Switched on"
0x6041	Statusword		Wait until state "Switched on" is reached => Statusword = xxxx xxxx x01x 0011 _b
0x6040	Controlword	0x0F	Switch to state "Operation enable" -> Powerstage active
0x6041	Statusword		Wait until state "Operation enable" is reached => Statusword = xxxx xxxx x01x 0111 _b
0x6040	Controlword	0x1F	Reference operation starts
0x6041	Statusword		Wait until reference is finished => Bit 12 in Statusword (Reference achieved) is set
0x6060	Modes of operation requested	0x08 0x01 -0x01	Set the mode of operation to the desired driving mode. 0x08 for cyclic synchronous position mode, 0x01 for profile position mode or -0x01 for jog velocity.
0x6061	Modes of operation display		Wait until Reference Mode equal to the requested mode.
Continue driving as specified in the DS402 standard.			

With the Profile Position Mode the XENAX® servo controller get the profile parameters like S-curve, acceleration, speed, position ect. from the superior controller (PC, PLC). The position profile trajectory is calculated in the XENAX® Xvi servo controller.

* A new Position set point will only be accepted, if the actual running position profile reached the target position.

Mode specific bits in the Controlword, 6040h

Bit 4	New Position
Bit 6	0: Absolute Position 1: Relative Distance

Mode specific bits in the Statusword, 6041h

Bit 10	Target position reached
Bit 12	Acknowledge of moving to target position
Bit 13	Following position error

5.2 Profile Position Mode

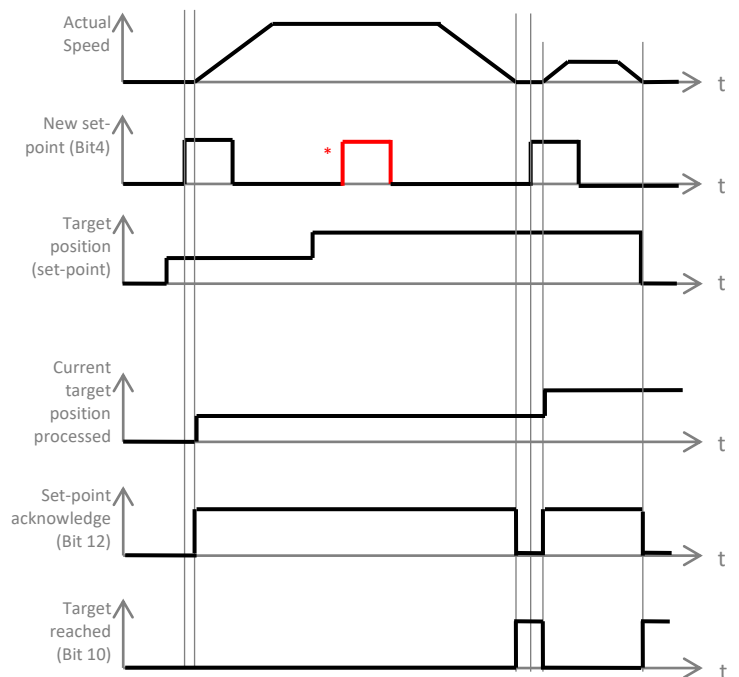

5.2.1 Example of profile position mode

Object	Description	Value	Activities
0x6060	Modes of Operation requested	0x01	Set Profile Position Mode
0x6061	Modes of Operation display		Wait until Profile Position Mode is active, Value = 0x01
0x6040	Controlword	0x0F	
0x60xx	Profile Position Mode parameters	0x	S-Curve (2000h), Acceleration (6083h), Speed (6081h), Following Position Error Window (6065h), Target Pos. Error Window (6067h)
0x607A	Target Position/Distance	0x	
0x6040	Controlword	0x1F	Start movement to target position absolute (Bit 6=0)
0x6041	Statusword		Target position reached, Acknowledge of moving to target pos. Bit 10 =True, Bit 12 = False
0x6040	Controlword	0x0F	
0x60xx	Profile Position Mode parameters	0x	S-Curve (2000h), Acceleration (6083h), Speed (6081h), Following Position Error Window (6065h), Target Pos. Error Window (6067h)
0x607A	Target Position/Distance	0x	
0x6040	Controlword	0x5F	Start movement to target position relative (Bit 6=1)
0x6041	Statusword		Target position reached, Acknowledge of moving to target pos. Bit 10 =True, Bit 12 = False

5.2.2 Example of Reset Profile Position Mode Failure

Object	Description	Value	Activities
0x6040	Controlword	0x80	Fault reset
0x6041	Statusword		Wait until fault is reset => Bit 3 in Statusword (Fault) is cleared
0x6040	Controlword	0x06	Ready to Switch on
Continue with power on sequence. No REFERENCE necessary.			

5.2.3 Example of "Halt" in profile position mode

An ongoing profile position movement can be aborted by setting the "Halt" bit in Controlword (Bit 8). For the deceleration ramp, the currently set acceleration value in object 6083h is used at the time the "Halt" bit is set.

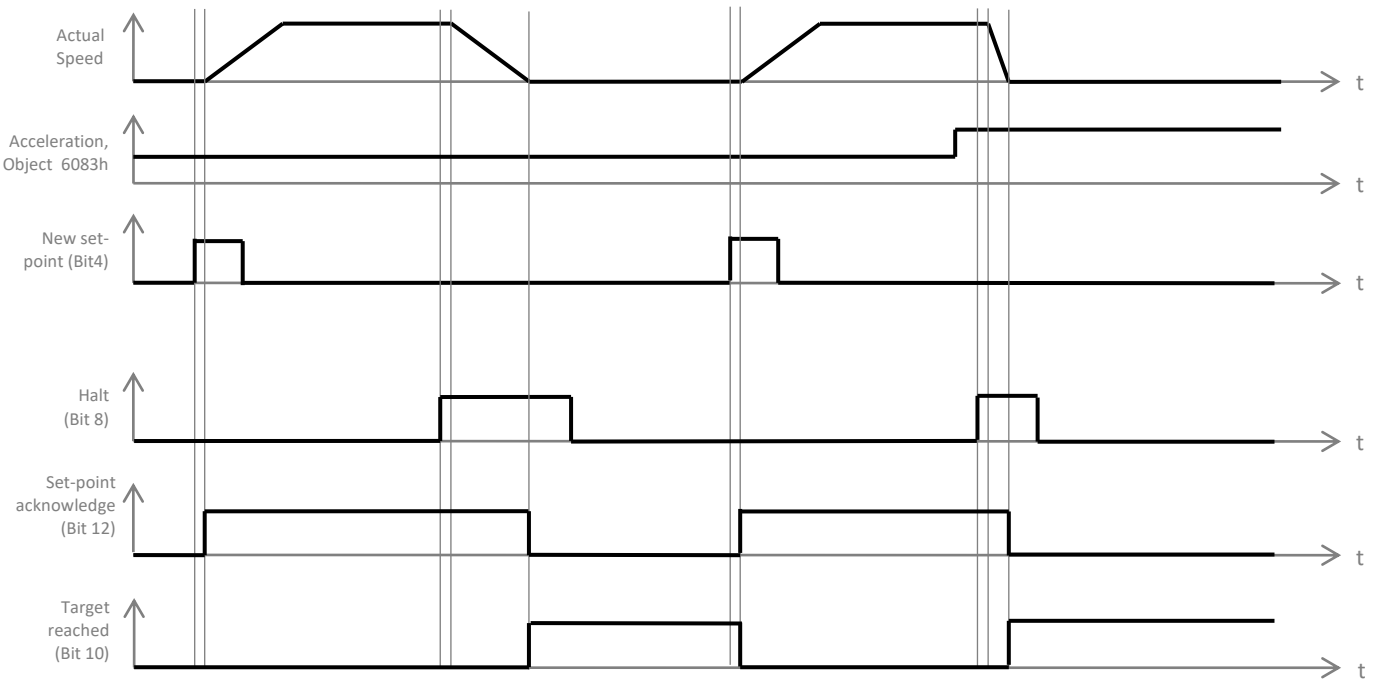

Object	Description	Value	Activities
0x6040	Controlword	0x0F	
0x60xx	Profile Position Mode parameters	0x	S-Curve (2000h), Acceleration (6083h), Speed (6081h), Following Position Error Window (6065h), Target Pos. Error Window (6067h), Target Position/Distance (607Ah)
0x6040	Controlword	0x1F	Start movement to target position absolute
0x6083	Acceleration	0x	If necessary, change Acceleration for "Halt" command
0x6040	Controlword	0x10F	Abort ongoing movement with "Halt" command
0x6041	Statusword		Target position reached, Acknowledge of moving to target pos. Bit 10 = True, Bit 12 = False

5.3 Cyclic Synchronous Position Mode

With the Cyclic Synchronous Position Mode the XENAX® servo controller get always new target positions in synchronous cycle time. The position trajectory is calculated in the superior controller (PC, PLC) which also transfer the target positions in a cyclic synchronous way.

A typical cycle time is 500µs, but the internal position control loop of the XENAX® servocontroller is 100µs. Now the servo controller calculates an interpolated position value on each internal position control loop. Therefore, the servo controller needs the synchronous cycle time of the superior controller in object 0x60C2 or 0x2007.

Mode specific bits in the Controlword, 6040h

Bit 4	Start moving
-------	--------------

5.3.1 Example of cyclic synchronous position mode

Object	Description	Value	Activities
0x6060	Modes of Operation requested	0x08	Set Cyclic Synchronous Position Mode
0x6061	Modes of Operation display		Wait until Cyclic Synchronous Position Mode is active, Value = 0x08
0x6040	Controlword	0x0F	
0x60C2	Synchronous cycle time		Example synchronous cycle time of 500µs
Sub-index 01	Bas value	0x05	Synchronous cycle Time in seconds = BASE x 10 ^{EXPONENT} 5 x 10 ⁻⁴ seconds
Sub-index 02	10 ^{EXPONENT}	0xFC	
0x6065	Following Position Error Window	0x	XENAX® monitors this following position error window
0x607A	Target Position	0x	Set target position equal to XENAX® internal absolute position
0x6040	Controlword	0x06	
0x6040	Controlword	0x1F	Start Cyclic synchronous position mode
0x607A	Target Position	0XXXXX 0XXXXX 0XXXXX : :	Set new target positions cyclically

5.3.2 Reset Cyclic Synchronous Position Mode Failure

Object	Description	Value	Activities
0x6040	Controlword	0x80	Fault reset
0x6040	Controlword	0x06	
0x607A	Target Position	0x	Set target position equal to XENAX® internal absolute position
0x6040	Controlword	0x0F	Power Continue, no REFERENCE necessary Cyclic Synchronous Position Mode operation enabled

With the Jenny Science specific Jog Mode the XENAX® servo controller get the jog parameters like acceleration, speed, direction ect. from the superior controller (PC, PLC). The jog trajectory is calculated in the XENAX® servo controller.

During an ongoing movement, the acceleration and speed can be changed with immediately impact.

Important: Jog Mode is not allowed in gantry configuration (if reference mode in object 6098h is set to >=3).

Mode specific bits in the Controlword, 6040h

Bit 4	Start Jog drive
Bit 6	0: Direction negative 1: Direction positive

Mode specific bits in the Statusword, 6041h

Bit 10	Constant speed reached
Bit 12	Speed is equal 0

5.4 Jog Mode Jenny Science specific

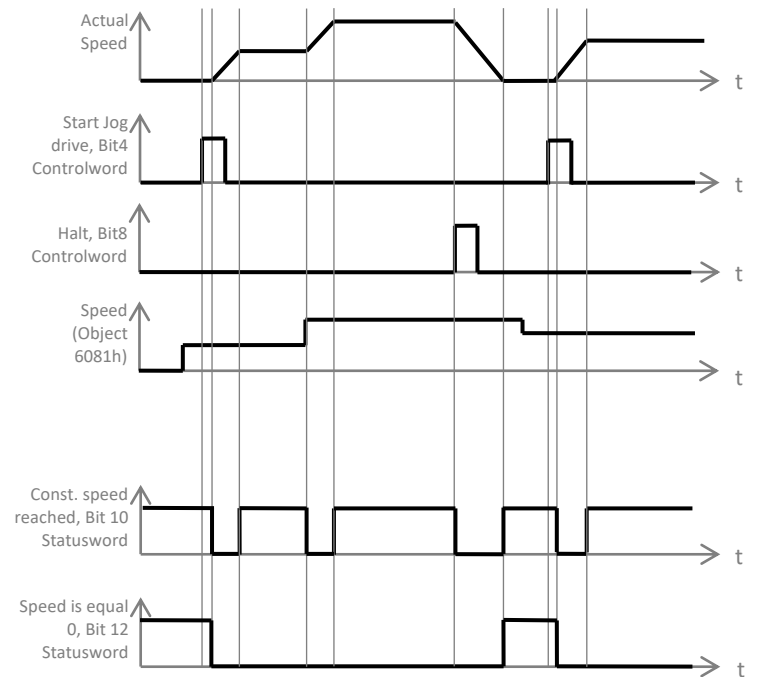

5.4.1 Example of Jog Mode Jenny Science specific

Object	Description	Value	Activities
0x6060	Modes of Operation requested	0xFF	Set Jog Mode Jenny Science specific (-1)
0x6061	Modes of Operation display		Wait until Jog Mode is active, Value = 0xFF (-1)
0x6040	Controlword	0x0F	
0x60xx	Jog Mode parameters	0x	Acceleration (6083h), Speed (6081h), Following Position Error Window (6065h), Target Pos. Error Window (6067h)
0x6040	Controlword	0x1F	Start Jog drive in negative direction (Bit 6=0)
0x6041	Statusword		Constant speed reached, Speed is not equal 0 Bit 10 =True, Bit 12 = False
0x6040	Controlword	0x11F	Stop Jog drive (set Halt, Bit 8 = 1)
0x6041	Statusword		Constant speed reached, Speed is equal 0 Bit 10 =True, Bit 12 = True

Object	Description	Value	Activities
0x6060	Modes of Operation requested	0xFF	Set Jog Mode Jenny Science specific (-1)
0x6061	Modes of Operation display		Wait until Jog Mode is active, Value = 0xFF (-1)
0x6040	Controlword	0x0F	
0x60xx	Jog Mode parameters	0x	Acceleration (6083h), Speed (6081h), Following Position Error Window (6065h), Target Pos. Error Window (6067h)
0x6040	Controlword	0x5F	Start Jog drive in positive direction (Bit 6=1)
0x6041	Statusword		Constant speed reached, Speed is not equal 0 Bit 10 =True, Bit 12 = False
0x6040	Controlword	0x11F	Stop Jog drive (set Halt, Bit 8 = 1)
0x6041	Statusword		Constant speed reached, Speed is equal 0 Bit 10 =True, Bit 12 = True

5.4.2 Example of Reset Jog Mode Failure

Object	Description	Value	Activities
0x6040	Controlword	0x80	Fault reset
0x6040	Controlword	0x06	Ready to Switch on
0x6040	Controlword	0x07	Switched on
0x6040	Controlword	0x0F	Power Continue, no REFERENCE necessary

6 Force Process Forceteq®

6.1 Forceteq® basic

Current based with self calibrated motor

The Forceteq® basic measurement technology is completely integrated in the XENAX® Xvi servo controller. This allows force-monitored control of all Jenny Science linear and rotary motor axes. The force is measured during the production process using the patented Forceteq® measurement technology, no external load cell is required. This allows you to acquire and record quality-relevant force-distance diagrams for all movements. Assembly operations can be monitored "in-process". Errors and discrepancies are detected immediately. This means better quality and higher throughput. Additional checking stations are no longer necessary.

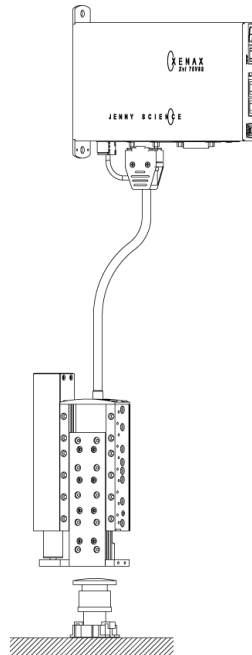

6.1.1 I_Force Calibration

With the patented function „force calibration“ of the XENAX® servo controller, the cogging-, load- and friction forces of the iron core LINAX® and ELAX® linear motor axes and the ROTAX® rotary axes from Jenny Science can be detected.

This is how it becomes possible to limit, monitor and control forces in processes.

The Axis moves from start- to endposition and measures cogging force and friction. All those Forces are then compensated in future drives. The following steps must be performed to execute a force calibration.

Object	Description	Value	Activities
0x6060	Modes of Operation requested	0x00	Set Mode of Operation to "no mode"
0x6061	Modes of Operation display		Wait until "no mode" is active, Value = 0x00
0x5003 Sub-Index 4	PO Position (absolute)	xxxx [inc]	Introduce the position to move to the start position of the force calibration in the next step.
0x5000	GP Go Position	0x3000	Move the axis to the start position of the force calibration
0x2006	Process Status Register		Wait for move to be done Bit 2 = False (IN_MOTION), Bit 3 = True (IN_POSTION) => Process Status Register = xxxx xxxx xxxx 1010 _b
0x5003 Sub-Index 5	WA Way (relative)	xxxx [inc]	Introduce the calibration way (relative) to the WA (Way)
0x5000	FC Force Calibration	0x4000	Start the force calibration "FC" drive by using the direct commands. Axis moves the Way forward and backward
0x2006	Process Status Register		Wait for force calibration to be done => Process Status Register Bit 14 falling edge
0x6060	Modes of operation requested	0x08 0x01 -0x01	Set the mode of operation to the desired driving mode. 0x08 for cyclic synchronous position mode, 0x01 for profile position mode or -0x01 for jog velocity.
0x6061	Modes of operation display		Wait until Reference Mode equal to the requested mode.

Continue driving as specified in the DS402 standard.

6.1.2 Force Limitation

Driving with limited force to an object or an end position if there are no objects (e.g. inserting parts). Or driving with very little force in order to detect an “object’s touching position”.

During a move performed in Profile Position, Cyclic Synchronous Position or Jog mode, the force limitation could be activated by writing the object Limit I_Force (6073h), the unit is [10mA]. This force limitation could be written at any time. No limitation occurs when the value is set to zero.

The bit 15 of Process Status Register (2006h), will be activated when the actual motor force reaches the force limitation value.

The actual motor force could be read from the I_Force_Actual (2005h) object, the unit is [mA] and the acquisition sampling rate depends on the bus cycle time ($\leq 5\text{kHz}$).

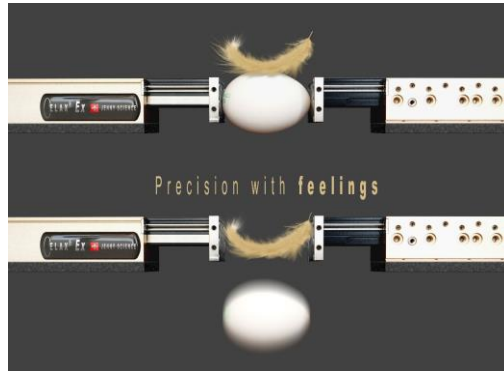

RxPDO		PLC -> XENAX®
0x6040	Controlword	
0x607A	Target Positon	
0x6073	Limit I_Force	

TxPDO		XENAX® -> PLC
0x6041	Statusword	
0x6064	Position Actual Value	
0x60F4	Actual Following position error	
0x2005	I_Force_Actual	
0x2006	Process Status Register (BIT 15)	

Note:

The Following error monitoring is deactivated during a motion with Force limitation active.
The new target position value must be set to the actual position before to start a new travel.

The current value „I_Force“ is proportional to the force.
Following graph shows corresponding relations for the different linear motor types.

LINAX® Linear Motor Axis	Force Constant	Minimal detectable force	Resolution
Lxc F04	50 * 10mA ~ 1N	0.5N	0.25N
Lxc F08	32 * 10mA ~ 1N	0.5N	0.25N
Lxc F10	28 * 10mA ~ 1N	0.5N	0.25N
Lxc F40	11 * 10mA ~ 1N	1N	0.5N
Lxe F40	11 * 10mA ~ 1N	10N	5N
Lxu/Lxs F60	10 * 10mA ~ 1N	10N	5N

ELAX® Linear Motor Slide	Force Constant	Minimal detectable force	Resolution
Ex F20	12 * 10mA ~ 1N	0.5N	0.25N

ROTAX® Rotary Motor Axis	Torque Constant	Minimal detectable torque	Resolution
Rxhq 110-50T1.5	2.5 * 10mA ~ 0.01Nm	0.06Nm	0.03Nm
Rxhq 50-12T0.3	8 * 10mA ~ 0.01Nm	0.02Nm	0.01Nm
Rxvp T0.04	23 * 10mA ~ 0.01Nm	0.006Nm	0.003Nm

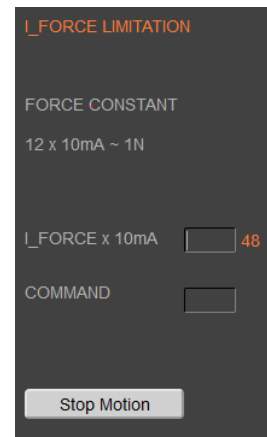

Example:

A compression die should apply no more than 4N force on an object.

Force Limitation with „LIMIT I_FORCE“
e.g.. ELAX® force constant: 12 x 10mA ~ 1 N
48 x 10mA ~ 4 N

6.1.3 Force Monitoring

Monitoring the force progression by defining sectors in a force/way diagram (e.g. inspecting switches). These sectors can automatically be adjusted towards the "object's touching position".

Inserted parts always have slight differences in height dimension. To compensate for this, a "touch position" can be recorded and then the force-distance measurement starts from this recorded point. With Forceteq® technology it is possible for the first time to execute a comprehensive quality control in a running process.

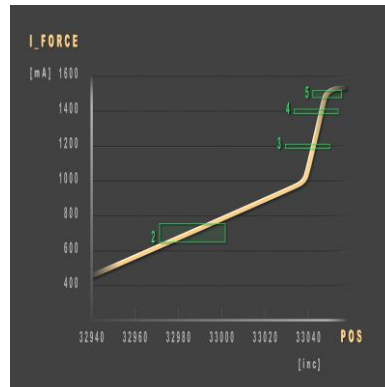

Sector Definition

Selecting sector number for which parameters shall be changed. After you can change the parameters for Position, I_Force and Transitions.

Object	Sub-Index	Description
0x5003	050	NSEC Preselected Sector Number
0x5003	039	SIFS Sector I Force Start
0x5003	040	SIFE Sector I Force End
0x5003	041	IFL I Force Low
0x5003	042	IFH I Force High
0x5003	051	STC Sector Transition Configuration

Sector Offset Used for touch position

Object	Value	Description
0x5000	0x6002	TPSO Take Position as Sector Offset

Sector Selection Select sectors which should be active.

Object	Sub-Index	Description
0x5003	057	SSEC Select Sectors

Sector Evaluation Shows the active sectors which force curve did not correctly pass through. In Cyclic Synchronous Position Mode, the monitoring must be first manually stoppen.

Object	Sub-Index	Description
0x5001	025	SIFF Sector I_Force Curve Failed Binary notation, LSB = Sector 1

Sector Evaluation in Cyclic Synchronous Position Mode In Cyclic Synchronous Position Mote (ModeOfOperation =8), the Force Monitoring must be startet before the motion and stopped after the motion for the Sector Evaluation.

Object	Value	Description
0x5000	0x6000	Start Force Monitoring
0x5000	0x6001	Stop Force Monitoring

6.2 Forceteq® pro

Precise with Signateq® and external load cell

With the Signateq® measuring amplifier, a standard strain gauge load cell can be connected directly to the XENAX® Xvi

75V8S servo controller. By using a load cell, the measurement and control adjustment of Forceteq® measurement technology becomes much more precise.

Due to the two-stage measuring amplifier, the signal noise is reduced and sensors with low sensitivity can be used with no problems.

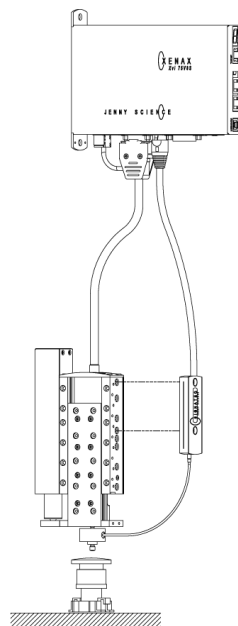

6.2.1 I_Force Calibration

With the patented function „force calibration“ of the XENAX® servo controller, the cogging-, load- and friction forces of the iron core LINAX® and ELAX® linear motor axes and the ROTAX® rotary axes from Jenny Science can be detected.

This allows more precise control and thus even better force accuracy at the external load cell.

The Axis moves from start- to endposition and measures cogging force and friction. All those Forces are then compensated in future drives. The following steps must be performed to execute a force calibration.

Object	Description	Value	Activities
0x6060	Modes of Operation requested	0x00	Set Mode of Operation to “no mode”
0x6061	Modes of Operation display		Wait until “no mode” is active, Value = 0x00
0x5003 Sub-Index 4	PO Position (absolute)	xxxx [inc]	Introduce the position to move to the start position of the force calibration in the next step.
0x5000	GP Go Position	0x3000	Move the axis to the start position of the force calibration
0x2006	Process Status Register		Wait for move to be done Bit 2 = False (IN_MOTION), Bit 3 = True (IN_POSTION) => Process Status Register = xxxx xxxx xxxx 1010 ₆
0x5003 Sub-Index 5	WA Way (relative)	xxxx [inc]	Introduce the calibration way (relative) to the WA (Way)
0x5000	FC Force Calibration	0x4000	Start the force calibration “FC” drive by using the direct commands. Axis moves the Way forward and backward
0x2006	Process Status Register		Wait for force calibration to be done => Process Status Register Bit 14 falling edge
0x6060	Modes of operation requested	0x08 0x01 -0x01	Set the mode of operation to the desired driving mode. 0x08 for cyclic synchronous position mode, 0x01 for profile position mode or -0x01 for jog velocity.
0x6061	Modes of operation display		Wait until Reference Mode equal to the requested mode.

Continue driving as specified in the DS402 standard.

6.2.2 Force Limitation

Driving with limited force to an object or an end position if there are no objects (e.g. inserting parts). Or driving with very little force in order to detect an “object’s touching position”.

During a move performed in Profile Position, Cyclic Synchronous Position or Jog mode, the force limitation could be activated by writing the object Limit Force (2009h), the unit is [mN]. This force limitation could be written at any time. No limitation occurs when the value is set to zero.

The bit 27 of Process Status Register (2006h), will be activated when the actual force reaches the force limitation value.

The actual force could be read from the Force_Actual (200Ah) object, the unit is [mN] and the acquisition sampling rate depends on the bus cycle time (<=5kHz).

RxPDO		PLC -> XENAX®
0x6040		Controlword
0x607A		Target Positon
0x2009		Limit Force

TxPDO		XENAX® -> PLC
0x6041		Statusword
0x6064		Position Actual Value
0x60F4		Actual Following position error
0x200A		Force_Actual
0x2006		Process Status Register (BIT 27)

Note:

The Following error monitoring is deactivated during a motion with Force limitation active.
The new target position value must be set to the actual position before to start a new travel.

6.2.3 Force Monitoring

Monitoring the force progression by defining sectors in a force/way diagram (e.g. inspecting switches). These sectors can automatically be adjusted towards the "object's touching position".

Inserted parts always have slight differences in height dimension. To compensate for this, a "touch position" can be recorded and then the force-distance measurement starts from this recorded point. With Forceteq® technology it is possible for the first time to execute a comprehensive quality control in a running process.

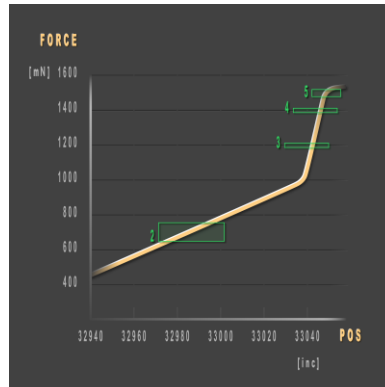

Select Forceteq® Mode

To switch from Forceteq® basic (FTM = 0, Default) to Forceteq® pro (FTM = 1)

Object	Sub-Index	Description
0x5003	092	FTM Forceteq® Mode

Sector Definition

Selecting sector number for which parameters shall be changed. After you can change the parameters for Position, Force and Transitions.

Object	Sub-Index	Description
0x5003	050	NSEC Preselected Sector Number
0x5003	039	SFS Sector Force Start
0x5003	040	SFE Sector Force End
0x5003	090	FH Force High
0x5003	091	FL Force Low
0x5003	051	STC Sector Transition Configuration

Sector Offset

Used for touch position

Object	Value	Description
0x5000	0x6002	TPSO Take Position as Sector Offset

Sector Selection

Select sectors which should be active.

Object	Sub-Index	Description
0x5003	057	SSEC Select Sectors

Sector Evaluation

Shows the active sectors which force curve did not correctly pass through. In Cyclic Synchronous Position Mode, the monitoring must be first manually stopped.

Object	Sub-Index	Description
0x5001	025	SFF Sector Force Curve Failed Binary notation, LSB = Sector 1

Sector Evaluation in Cyclic Synchronous Position Mode

In Cyclic Synchronous Position Mode (ModeOfOperation =8), the Force Monitoring must be started before the motion and stopped after the motion for the Sector Evaluation.

Object	Value	Description
0x5000	0x6000	Start Force Monitoring
0x5000	0x6001	Stop Force Monitoring

7 EtherCAT

7.1 Predefined EtherCAT PDO

7.1.1 EtherCAT in Profile Position Mode

The position profile trajectory is calculated in the XENAX® Xvi servo controller.

With dynamic PDO mapping the predefined PDO configuration of the EtherCAT interface can be changed.

RxPDO 1 (1600) PLC/PC -> XENAX®	
6040	Controlword

RxPDO 2 (1601) PLC/PC -> XENAX®	
6040	Controlword
607A	Target Position

RxPDO 17 (1611) PLC/PC -> XENAX®	
6040	Controlword
607A	Target Position
60FE	Digital Outputs

RxPDO 18 (1612) PLC/PC -> XENAX®	
6040	Controlword
607A	Target Position
6081	Speed
6083	Acceleration
6084	Deceleration (reserved for future)
2000	S-curve
6065	Following position error window
6067	Target position error window
60FE	Digital Outputs

TxPDO 1 (1A00) XENAX® -> PLC/PC	
6041	Statusword

TxPDO 2 (1A01) XENAX® -> PLC/PC	
6041	Statusword
6064	Actual Position

TxPDO 17 (1A10) XENAX® -> PLC/PC	
6041	Statusword
6064	Actual Position
60FD	Digital Inputs

TxPDO 18 (1A11) XENAX® -> PLC/PC	
6041	Statusword
6064	Actual Position
60F4	Actual Following position error
6078	Actual Current
60FD	Digital Inputs

7.1.2 EtherCAT in Cyclic synchronous Position Mode

With the Cyclic Synchronous Position Mode the XENAX® servo controller get always new target positions in synchronous cycle time.

RxPDO 2 (1601, TrioMotion) PLC/PC -> XENAX®	
6040	Controlword
607A	Target Position

RxPDO 21 (1615, TwinCAT) PLC/PC -> XENAX®	
6040	Controlword
607A	Target Position
6065	Following position error window
6067	Target position error window
6073	I Force Max

TxPDO 2 (1A01, TrioMotion) XENAX® -> PLC/PC	
6041	Statusword
6064	Actual Position

TxPDO 21 (1A13, TwinCAT) XENAX® -> PLC/PC	
6041	Statusword
6064	Actual Position
60F4	Actual Following position error
6078	Actual Current
2006	Process Status Register

7.1.3 EtherCAT Object detail Receive PDO

PLC/PC -> XENAX®

Their structure is as follows:
Object (16bit) Sub-index (8bit) Nbr of Entries (8bit)

Receive PDO 1, 1600h

Sub-index	Description	Data Type	Access (PreOp/SafeOp/Op)	Default Value	Lower Limit	Upper Limit
000	Nbr of Entries	PDO_MAPPING	RW/RW/RW	0x01	0x0	0x08
001	Controlword	Unsigned 32	RW/RW/RW	0x60400010	0x0	0xFFFFFFFF

Receive PDO 2, 1601h

Sub-index	Description	Data Type	Access (PreOp/SafeOp/Op)	Default Value	Lower Limit	Upper Limit
000	Nbr of Entries	PDO_MAPPING	RW/RW/RW	0x02	0x0	0x08
001	Controlword	Unsigned 32	RW/RW/RW	0x60400010	0x0	0xFFFFFFFF
002	Target Position	Unsigned 32	RW/RW/RW	0x607A0020	0x0	0xFFFFFFFF

Receive PDO 17, 1611h

Sub-index	Description	Data Type	Access (PreOp/SafeOp/Op)	Default Value	Lower Limit	Upper Limit
000	Nbr of Entries	PDO_MAPPING	RW/RW/RW	0x03	0x0	0x08
001	Controlword	Unsigned 32	RW/RW/RW	0x60400010	0x0	0xFFFFFFFF
002	Target Position	Unsigned 32	RW/RW/RW	0x607A0020	0x0	0xFFFFFFFF
003	Digital Outputs	Unsigned 32	RW/RW/RW	0x60FE0120	0x0	0xFFFFFFFF

Receive PDO 18, 1612h

Sub-index	Description	Data Type	Access (PreOp/SafeOp/Op)	Default Value	Lower Limit	Upper Limit
000	Nbr of Entries	PDO_MAPPING	RW/RW/RW	0x09	0x0	0x09
001	Controlword	Unsigned 32	RW/RW/RW	0x60400010	0x0	0xFFFFFFFF
002	Target Position	Unsigned 32	RW/RW/RW	0x607A0020	0x0	0xFFFFFFFF
003	Speed,	Unsigned 32	RW/RW/RW	0x60810020	0x0	0xFFFFFFFF
004	Acceleration	Unsigned 32	RW/RW/RW	0x60830020	0x0	0xFFFFFFFF
005	Deceleration (reserved for future)	Unsigned 32	RW/RW/RW	0x60840020	0x0	0xFFFFFFFF
006	S-Curve	Unsigned 32	RW/RW/RW	0x20000020	0x0	0xFFFFFFFF
007	Following Position Error Window	Unsigned 32	RW/RW/RW	0x60650020	0x0	0xFFFFFFFF
008	Target Position Error Window	Unsigned 32	RW/RW/RW	0x60670020	0x0	0xFFFFFFFF
009	Digital Outputs	Unsigned 32	RW/RW/RW	0x60FE0120	0x0	0xFFFFFFFF

Receive PDO 19, 1613h

Currently not implemented, reserved for future.

Sub-index	Description	Data Type	Access (PreOp/SafeOp/Op)	Default Value	Lower Limit	Upper Limit
000	Nbr of Entries	PDO_MAPPING	RW/RW/RW	0x05	0x0	0x08
001	Controlword	Unsigned 32	RW/RW/RW	0x60400010	0x0	0xFFFFFFFF
002	Speed	Unsigned 32	RW/RW/RW	0x60810020	0x0	0xFFFFFFFF
003	(Reserved for future)	Unsigned 32	RW/RW/RW	0x20010020	0x0	0xFFFFFFFF
004	(Reserved for future)	Unsigned 32	RW/RW/RW	0x20030020	0x0	0xFFFFFFFF
005	Digital Outputs	Unsigned 32	RW/RW/RW	0x60FE0120	0x0	0xFFFFFFFF

Receive PDO 20, 1614h

Currently not implemented, reserved for future.

Sub-index	Description	Data Type	Access (PreOp/SafeOp/Op)	Default Value	Lower Limit	Upper Limit
000	Nbr of Entries	PDO_MAPPING	RW/RW/RW	0x03	0x0	0x08
001	Controlword	Unsigned 32	RW/RW/RW	0x60400010	0x0	0xFFFFFFFF
002	(Reserved for future)	Unsigned 32	RW/RW/RW	0x20020020	0x0	0xFFFFFFFF
003	Digital Outputs	Unsigned 32	RW/RW/RW	0x60FE0120	0x0	0xFFFFFFFF

Receive PDO 21, 1615h

Sub-index	Description	Data Type	Access (PreOp/SafeOp/Op)	Default Value	Lower Limit	Upper Limit
000	Nbr of Entries	PDO_MAPPING	RW/RW/RW	0x05	0x0	0x08
001	Controlword	Unsigned 32	RW/RW/RW	0x60400010	0x0	0xFFFFFFFF
002	Target Position	Unsigned 32	RW/RW/RW	0x607A0020	0x0	0xFFFFFFFF
003	Following position error window	Unsigned 32	RW/RW/RW	0x60650020	0x0	0xFFFFFFFF
004	Target position error window	Unsigned 32	RW/RW/RW	0x60670020	0x0	0xFFFFFFFF
005	I Force Max	Unsigned 32	RW/RW/RW	0x60730010	0x0	0xFFFFFFFF

7.1.4 EtherCAT Object detail Transmit PDO

XENAX® -> PLC/PC

Contains the mapping for the PDOs the device is able to transmit. The Sub-index 0h contains the number of valid entries within the mapping record. This number of entries is also the number of the application variables which shall be transmitted with the corresponding PDO.

The Sub-index from 1h to number of entries contain the information about the mapped application variables.

Transmit PDO 1, 1A00h

Sub-index	Description	Data Type	Access (PreOp/SafeOp/Op)	Default Value	Lower Limit	Upper Limit
000	Nbr of Entries	PDO_MAPPING	RW/RW/RW	0x01	0x0	0x08
001	Statusword	Unsigned 32	RW/RW/RW	0x60410010	0x0	0xFFFFFFFF

Transmit PDO 2, 1A01h

Sub-index	Description	Data Type	Access (PreOp/SafeOp/Op)	Default Value	Lower Limit	Upper Limit
000	Nbr of Entries	PDO_MAPPING	RW/RW/RW	0x02	0x0	0x08
001	Statusword	Unsigned 32	RW/RW/RW	0x60410010	0x0	0xFFFFFFFF
002	Actual Position	Unsigned 32	RW/RW/RW	0x60640020	0x0	0xFFFFFFFF

Transmit PDO 17, 1A10h

Sub-index	Description	Data Type	Access (PreOp/SafeOp/Op)	Default Value	Lower Limit	Upper Limit
000	Nbr of Entries	PDO_MAPPING	RW/RW/RW	0x03	0x0	0x08
001	Statusword	Unsigned 32	RW/RW/RW	0x60410010	0x0	0xFFFFFFFF
002	Actual Position	Unsigned 32	RW/RW/RW	0x60640020	0x0	0xFFFFFFFF
003	Digital Inputs	Unsigned 32	RW/RW/RW	0x60FD0020	0x0	0xFFFFFFFF

Transmit PDO 18, 1A11h

Sub-index	Description	Data Type	Access (PreOp/SafeOp/Op)	Default Value	Lower Limit	Upper Limit
000	Nbr of Entries	PDO_MAPPING	RW/RW/RW	0x05	0x0	0x08
001	Statusword	Unsigned 32	RW/RW/RW	0x60410010	0x0	0xFF
002	Actual Position	Unsigned 32	RW/RW/RW	0x60640020	0x0	0xFF
003	Actual Following position error	Unsigned 32	RW/RW/RW	0x60F40020	0x0	0xFF
004	Actual Current	Unsigned 32	RW/RW/RW	0x60780010	0x0	0xFF
005	Digital Inputs	Unsigned 32	RW/RW/RW	0x60FD0020	0x0	0xFF

Transmit PDO 19, 1A12h

Currently not implemented, reserved for future.

Sub-index	Description	Data Type	Access (PreOp/SafeOp/Op)	Default Value	Lower Limit	Upper Limit
000	Nbr of Entries	PDO_MAPPING	RW/RW/RW	0x04	0x0	0x08
001	Statusword	Unsigned 32	RW/RW/RW	0x60410010	0x0	0xFF
002	Actual Position	Unsigned 32	RW/RW/RW	0x60640020	0x0	0xFF
003	I Force Actual	Unsigned 32	RW/RW/RW	0x20050020	0x0	0xFF
004	Digital Inputs	Unsigned 32	RW/RW/RW	0x60FD0020	0x0	0xFF

Transmit PDO 21, 1A13h

Sub-index	Description	Data Type	Access (PreOp/SafeOp/Op)	Default Value	Lower Limit	Upper Limit
000	Nbr of Entries	PDO_MAPPING	RW/RW/RW	0x05	0x0	0x08
001	Statusword	Unsigned 32	RW/RW/RW	0x60410010	0x0	0xFF
002	Actual Position	Unsigned 32	RW/RW/RW	0x60640020	0x0	0xFF
003	Actual Following position error	Unsigned 32	RW/RW/RW	0x60F40020	0x0	0xFF
004	Actual Current	Unsigned 32	RW/RW/RW	0x60780010	0x0	0xFF
005	Process Status Register	Unsigned 32	RW/RW/RW	0x20060020	0x0	0xFF

8 Powerlink

8.1 Powerlink PDO Parameter

8.1.1 Powerlink PDO_RxCommParam_0h, 1400h

A device may implement less than the maximum number of 256 objects. The number of objects shall be equal to the number of RPDO channels provided by the device.

Objects shall be implemented starting at Index 1400h.

The validity of the respective object depends on the NumberOfEntries_U8 entry of the respective RPDO mapping index PDO_RxMappParam_XXh.

To change the PDO communication parameter, first the PDO has to be deactivated by means of setting PDO_RxMappParam_XXh.NumberOfEntries to 0.

Sub-index	Description	Data Type	PDO Mapping	Access	Default Value
000	Nbr of Entries	PDO_COMMPAR_REC	no	RO	0x02
001	NodeID_U8	Unsigned 8	no	RW	0x00
002	MappingVersion_U8	Unsigned 8	no	RW	0x00

8.1.2 Powerlink PDO_RxMappParam_0h, 1600h

To allow access by name _XXh shall be replaced by a name index. Name index shall be _00h if object index is 1600h. It shall be incremented up to _FFh corresponding to object index 16FFh.

To change the PDO mapping, first the PDO has to be deactivated by means of setting NumberOfEntries to 0. The objects may then be remapped.

Sub-index	Description	Data Type	PDO Mapping	Access	Default Value
000	Nbr of Entries	Unsigned 8	no	RW	0x0
001	ObjectMapping 1	Unsigned 64	no	RW	0x0000000000000000
002	ObjectMapping 2	Unsigned 64	no	RW	0x0000000000000000
003	ObjectMapping 3	Unsigned 64	no	RW	0x0000000000000000
004	ObjectMapping 4	Unsigned 64	no	RW	0x0000000000000000
005	ObjectMapping 5	Unsigned 64	no	RW	0x0000000000000000
006	ObjectMapping 6	Unsigned 64	no	RW	0x0000000000000000
007	ObjectMapping 7	Unsigned 64	no	RW	0x0000000000000000
008	ObjectMapping 8	Unsigned 64	no	RW	0x0000000000000000

8.1.3 Powerlink PDO_TxCommParam_0h, 1800h

The validity of the respective object depends on the
 NumberOfEntries_U8 entry of the respective RPDO mapping index
 PDO_TxMappParam_XXh.

Sub-index	Description	Data Type	PDO Mapping	Access	Default Value
000	Nbr of Entries	PDO_COMMPAR_REC	no	RO	0x02
001	NodeID_U8	Unsigned 8	no	RW	0x00
002	MappingVersion_U8	Unsigned 8	no	RW	0x00

8.1.4 Powerlink PDO_TxMappParam_0h, 1A00h

To allow access by name _XXh shall be replaced by a name index.
 Name index shall be _00h if object index is 1A00h.
 It shall be incremented up to _FFh corresponding to object index
 1AFFh.
 To change the PDO mapping, first the PDO has to be deactivated by
 means of setting NumberOfEntries to 0.
 The objects may then be remapped.

Sub-index	Description	Data Type	PDO Mapping	Access	Default Value
000	Nbr of Entries	Unsigned 8	no	RW	0x0
001	ObjectMapping 1	Unsigned 64	no	RW	0x0000000000000000
002	ObjectMapping 2	Unsigned 64	no	RW	0x0000000000000000
003	ObjectMapping 3	Unsigned 64	no	RW	0x0000000000000000
004	ObjectMapping 4	Unsigned 64	no	RW	0x0000000000000000
005	ObjectMapping 5	Unsigned 64	no	RW	0x0000000000000000
006	ObjectMapping 6	Unsigned 64	no	RW	0x0000000000000000
007	ObjectMapping 7	Unsigned 64	no	RW	0x0000000000000000
008	ObjectMapping 8	Unsigned 64	no	RW	0x0000000000000000

9 CANopen

9.1 CANopen PDO Parameter

9.1.1 CANopen Receive PDO Comm Param 1, 1400h

It contains the communication parameters of the current PDO the device is able to receive.

Sub-index 0 contains the number of PDO-parameters implemented. Sub-index 1 describes the COB-ID. If bit 31 is set the PDO is disabled.

The transmission mode is defined by Sub-index 2. An inhibit time can be defined on Sub-index 3 in 100 us. The 4th Sub-index contains the priority class of the PDO.

Important: The 4th Sub-index must not be read or written! At the 5th Sub-index can be defined an event time for asynchrony pdos.

Sub-index	Description	Data Type	Access	PDO Mapping	Unit	Default Value
000	Nbr of Entries	PDO_COMM_PAR	RO	no		0x05
001	COB-ID	Unsigned 32	R/W	no		0x00000200
002	Transmission Type	Unsigned 8	R/W	no		0xFF
003	Inhibit Time	Unsigned 16	R/W	no	100 us	0x0
004	Compatibility Entry	Unsigned 8	R/W	no		0x0
005	Event Timer	Unsigned 16	R/W	no	ms	0x0

9.1.2 CANopen Receive PDO Comm Param 2, 1401h

Sub-index	Description	Data Type	Access	PDO Mapping	Unit	Default Value
000	Nbr of Entries	PDO_COMM_PAR	RO	no		0x05
001	COB-ID	Unsigned 32	R/W	no		0x00000300
002	Transmission Type	Unsigned 8	R/W	no		0xFF
003	Inhibit Time	Unsigned 16	R/W	no	100 us	0x0
004	Compatibility Entry	Unsigned 8	R/W	no		0x0
005	Event Timer	Unsigned 16	R/W	no	ms	0x0

9.1.3 CANopen Receive PDO Comm Param 17-24, 1410h-1417h

Sub-index	Description	Data Type	Access	PDO Mapping	Unit	Default Value
000	Nbr of Entries	PDO_COMM_PAR	RO	no		0x05
001	COB-ID	Unsigned 32	R/W	no		0x80000000
002	Transmission Type	Unsigned 8	R/W	no		0xFE
003	Inhibit Time	Unsigned 16	R/W	no	100 us	0x0
004	Compatibility Entry	Unsigned 8	R/W	no		0x0
005	Event Timer	Unsigned 16	R/W	no	ms	0x0

9.1.4 CANopen Receive PDO Mapping Param 1, 1600h

It contains the mapping parameters of the first PDO the device is able to receive.

Sub-index 0 contains the number of the mapped data objects. All further entries define the data by it's index, sub-index and length. The conten of PDO 1 is fixed. Writing this object will have no effect.

Sub-index	Description	Data Type	Access	PDO Mapping	Unit	Default Value
000	Nbr of Entries		R/W	yes		0x01
001	Controlword	Unsigned 32	R/W	yes		0x60400010

9.1.5 CANopen Receive PDO Mapping Param 2, 1601h

The conten of PDO 2 is fixed. Writing this object will have no effect.

Sub-index	Description	Data Type	Access	PDO Mapping	Unit	Default Value
000	Nbr of Entries		R/W	yes		0x02
001	Controlword	Unsigned 32	R/W	yes		0x60400010
002	Target Position	Unsigned 32	R/W	yes		0x607A0020

9.1.6 CANopen Receive PDO Mapping Param 17, 1610h

Sub-index	Description	Data Type	Access	PDO Mapping	Unit	Default Value
000	Nbr of Entries		R/W	yes		0x01
001	Digital Outputs	Unsigned 32	R/W	no		0x60FE0120

9.1.7 CANopen Receive PDO Mapping Param 18, 1611h

Sub-index	Description	Data Type	Access	PDO Mapping	Unit	Default Value
000	Nbr of Entries		R/W	no		0x02
001	Acceleration	Unsigned 32	R/W	no		0x60830020
002	S-Curve	Unsigned 32	R/W	no		0x20000020

9.1.8 CANopen Receive PDO Mapping Param 19, 1612h

Sub-index	Description	Data Type	Access	PDO Mapping	Unit	Default Value
000	Nbr of Entries		R/W	no		0x01
001	Speed	Unsigned 32	R/W	no		0x60810020

9.1.9 CANopen Receive PDO Mapping Param 20, 1613h

Sub-index	Description	DataType	Access	PDO Mapping	Unit	Default Value
000	Nbr of Entries		R/W	no		0x02
001	Following Position Error Window	Unsigned 32	R/W	no		0x60650020
002	Target Position Error Window	Unsigned 32	R/W	no		0x60670020

9.1.10 CANopen Receive PDO Mapping Param 21, 1614h

Sub-index	Description	DataType	Access	PDO Mapping	Unit	Default Value
000	Nbr of Entries		R/W	no		0x01
001	I Force Max	Unsigned 32	R/W	no		0x60730010

9.1.11 CANopen Receive PDO Mapping Param 24, 1617h

Sub-index	Description	DataType	Access	PDO Mapping	Unit	Default Value
000	Nbr of Entries		R/W	no		0x02
001	Controlword	Unsigned 32	R/W	no		0x60400010
002	(Reserved for future)	Unsigned 32	R/W	no		0x20020020

9.1.12 CANopen Transmit PDO Comm Param 1, 1800h

It contains the communication parameters of the current PDO the device is able to transmit.

Sub-index 0 contains the number of PDO-parameters implemented.

Sub-index 1 describes the COB-ID. If bit 31 is set the PDO is disabled.

The transmission mode is defined by Sub-index 2.

An inhibit time can be defined on Sub-index 3 in 100 us.

Important: The 4th Sub-index must not be read or written!

At the 5th Sub-index can be defined an event time for asynchrony pdos.

Sub-index	Description	Data Type	Access	PDO Mapping	Unit	Default Value
000	Nbr of Entries	PDO_COMM_PAR	RO	no		0x05
001	COB-ID	Unsigned 32	R/W	no		0x00000180
002	Transmission Type	Unsigned 8	R/W	no		0xFF
003	Inhibit Time	Unsigned 16	R/W	no	100 us	0x0
004	Compatibility Entry	Unsigned 8	R/W	no		0x0
005	Event Timer	Unsigned 16	R/W	no	ms	0x0

9.1.13 CANopen Transmit PDO Comm Param 2, 1801h

Sub-index	Description	Data Type	Access	PDO Mapping	Unit	Default Value
000	Nbr of Entries	PDO_COMM_PAR	RO	no		0x05
001	COB-ID	Unsigned 32	R/W	no		0x00000280
002	Transmission Type	Unsigned 8	R/W	no		0xFF
003	Inhibit Time	Unsigned 16	R/W	no	100 us	0x0
004	Compatibility Entry	Unsigned 8	R/W	no		0x0
005	Event Timer	Unsigned 16	R/W	no	ms	0x0

9.1.14 CANopen Transmit PDO Comm Param 17-24, 1810h - 1817h

Sub-index	Description	Data Type	Access	PDO Mapping	Unit	Default Value
000	Nbr of Entries	PDO_COMM_PAR	RO	no		0x05
001	COB-ID	Unsigned 32	R/W	no		0x80000000
002	Transmission Type	Unsigned 8	R/W	no		0xFE
003	Inhibit Time	Unsigned 16	R/W	no	100 us	0x0
004	Compatibility Entry	Unsigned 8	R/W	no		0x0
005	Event Timer	Unsigned 16	R/W	no	ms	0x0

9.1.15 CANopen Transmit PDO Mapping Param 1, 1A00h

Contains the mapping for the PDOs the device is able to transmit.

The subindex 0h contains the number of valid entries within the mapping record. This number of entries is also the number of the application variables which shall be transmitted with the corresponding PDO.

The subindex from 1h to number of entries contain the information about the mapped application variables. These entries describe the PDO contents by their index, subindex and length.

All three values are hexa-decimal coded.

The length entry contains the length of the object in bits (1..40h). This parameter can be used to verify the overall mapping length. It is mandatory.

The content of PDO 1 is fixed. Writing this object will have no effect.

Sub-index	Description	Data Type	Access	PDO Mapping	Unit	Default Value
000	Nbr of Entries		R/W	yes		0x01
001	Statusword	Unsigned 32	R/W	yes		0x60410010

9.1.16 CANopen Transmit PDO Mapping Param 2, 1A01h

The content of PDO 2 is fixed. Writing this object will have no effect.

Sub-index	Description	Data Type	Access	PDO Mapping	Unit	Default Value
000	Nbr of Entries		R/W	yes		0x02
001	Statusword	Unsigned 32	R/W	yes		0x60410010
002	Actual Position	Unsigned 32	R/W	yes		0x60640020

9.1.17 CANopen Transmit PDO Mapping Param 17, 1A10h

Sub-index	Description	Data Type	Access	PDO Mapping	Unit	Default Value
000	Nbr of Entries		R/W	yes		0x01
001	Digital Inputs	Unsigned 32	R/W	yes		0x60FD0020

9.1.18 CANopen Transmit PDO Mapping Param 20, 1A13h

Sub-index	Description	Data Type	Access	PDO Mapping	Unit	Default Value
000	Nbr of Entries		R/W	yes		0x02
001	Actual Following Position Error	Unsigned 32	R/W	yes		0x60F40020
002	Process Status Register	Unsigned 32	R/W	yes		0x20060020

9.1.19 CANopen Transmit PDO Mapping Param 21, 1A14h

Sub-index	Description	Data Type	Access	PDO Mapping	Unit	Default Value
000	Nbr of Entries		R/W	yes		0x01
001	Actual Current	Unsigned 32	R/W	yes		0x60780010

9.1.20 CANopen Transmit PDO Mapping Param 23, 1A16h

Sub-index	Description	DataType	Access	PDO Mapping	Unit	Default Value
000	Nbr of Entries		R/W	yes		0x02
001	I Force Actual	Unsigned 32	R/W	yes		0x20050020
002	Process Status Register	Unsigned 32	R/W	yes		0x20060020

9.1.21 CANopen Transmit PDO Mapping Param 24, 1A17h

Sub-index	Description	DataType	Access	PDO Mapping	Unit	Default Value
000	Nbr of Entries		R/W	yes		0x02
001	Statusword	Unsigned 32	R/W	yes		0x60410010
002	I Force Actual	Unsigned 32	R/W	yes		0x20050020

9.2 Predefined CANopen PDO

9.2.1 CANopen in Profile Position Mode

The position profile trajectory is calculated in the XENAX® Xvi servo controller.

With dynamic PDO mapping the predefined PDO configuration of the CANopen interface can be changed.

RxPDO 1 (1600) PLC/PC -> XENAX®	
6040	Controlword

RxPDO 2 (1601) PLC/PC -> XENAX®	
6040	Controlword
607A	Target Position

RxPDO 17 (1610) PLC/PC -> XENAX®	
60FE	Digital Outputs

RxPDO 18 (1611) PLC/PC -> XENAX®	
6083	Acceleration
2000	S-Curve

RxPDO 19 (1612) PLC/PC -> XENAX®	
6081	Speed

RxPDO 20 (1613) PLC/PC -> XENAX®	
6065	Following Position Error Window
6067	Target Position Error Window

RxPDO 21 (1614) PLC/PC -> XENAX®	
6073	I Force Max

RxPDO 24 (1617) PLC/PC -> XENAX®	
6040	Controlword
2002	(Reserved for future)

TxPDO 1 (1A00) XENAX® -> PLC/PC	
6041	Statusword

TxPDO 2 (1A01) XENAX® -> PLC/PC	
6041	Statusword
6064	Actual Position

TxPDO 17 (1A10) XENAX® -> PLC/PC	
60FD	Digital Inputs

TxPDO 20 (1A13) XENAX® -> PLC/PC	
60F4	Actual Following Position Error
2006	Process Status Register

TxPDO 21 (1A14) XENAX® -> PLC/PC	
6078	Actual Current

TxPDO 23 (1A16) XENAX® -> PLC/PC	
2005	I Force Actual
2006	Process Status Register

TxPDO 24 (1A17) XENAX® -> PLC/PC	
6041	Statusword
2005	I Force Actual

Notes

Fixed Mapping of PDO1, 2
Variable Mapping of PDO17..24

Transmission Type all TxPDOs:

0xFF send PDO's on change of statusword (default for TxPDO1/2)
0xFE send PDO on change of any mapped objects (default for TxPDO17..24)

Notes

This instruction manual contains copyright protected information. All rights are reserved.

This document may not be in its entirety or partially copied, duplicated or translated without the prior consent of Jenny Science AG.

Jenny Science AG grants no guarantee on, or will be held responsible for, any incidents resulting from false information.

Information in this instruction manual is subject to change.

Jenny Science AG
Sandblatte 11
CH-6026 Rain, Schweiz

Tel +41 (0) 41 255 25 25

www.jennyscience.ch
info@jennyscience.ch