

**XENAX® Xvi 75V8, Xvi 75V8S and
Xvi 48V8 Bus coupling**

EtherNet/IP™

V1.13 Edition January 2025



This bus coupling manual describes the
EtherNet/IP Protocol stack of the
XENAX® Xvi 75V8, Xvi 75V8S and Xvi 48V8
servo controller.

Table of contents

1 Bus module	4
1.1 Protocol upgrade	4
1.2 Required resources	5
1.3 LED status	5
1.4 IP Configuration	6
1.5 Factory reset	8
2 Messaging over EtherNet/IP	9
2.1 Supported features	9
2.2 Length	9
2.3 Explicit Messaging	10
2.3.1 Overview	10
2.3.2 Status Codes	11
2.3.1 XENAX General Parameter (0x64)	12
2.3.2 XENAX Command (0x65)	14
2.3.4 XENAX Drive Parameter (0x66)	22
2.3.5 XENAX Drive Parameter (0x67)	33
2.3.6 XENAX Drive Parameter (0x68)	33
2.3.7 XENAX Drive Parameter (0x69)	34
2.3.8 Forceteq pro Parameter (0x6E)	35
2.3.9 Identity (0x01)	36
2.3.10 Message Router (0x02)	37
2.3.11 Assembly (0x04)	37
2.3.12 File (0x37)	37
2.3.13 Device Level Ring (0x47)	38
2.3.14 QoS (0x48)	38
2.3.15 TCP/IP Interface (0xF5)	39
2.3.16 Ethernet Link (0xF6)	39
2.4 Implicit Messaging	40
2.4.1 Connections	40
2.4.2 Output Assembly	41
2.4.4 Input Assembly	47
3 DS402 drive profile	50
3.1 DS402 state machine	50
3.2 Examples	51
3.2.1 Reference	51
3.2.3 Profile Position Mode	55
3.2.4 Jog Mode Jenny Science specific	58

J E N N Y S C I E N C E

moving precisely, within tight space

1 Bus module

To connect the XENAX® servo controller to a superior PLC or PC, an EtherNet/IP bus module is available, mountable directly to the XENAX® servo controller.

Article number of the bus module: 130 10 20

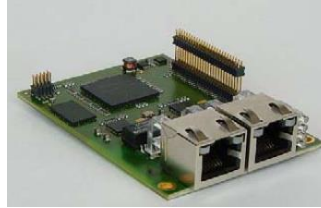

1.1 Protocol upgrade

At delivery time of XENAX® servo controller, the latest bus protocol stack version is installed in the bus module.

An upgrade could be installed with WebMotion in menu *firmware / update -> BUS-MODULE*

The bus protocol software *Xenax_XXXXXX_protocol_Vx.x.flash* is available on www.jennyscience.ch.



Important:
The upgraded bus protocol version has to be activated by power OFF and power ON.
You could check the installed version with WebMotion in menu *firmware / version-> BUS-MODULE*



1.2 Required resources

The EtherNet/IP protocol stack is provided on www.jennyscience.ch under XENAX® Servocontroller→Firmware Bus Module. It includes the bus module protocol stack software together with the electronic datasheet. The electronic datasheet can also be uploaded directly from the device, for example with the “Upload EDS file from device”- function in Rockwell Automation communication software “RSLinx”.

Description	Filename
Electronic datasheet of EtherNet/IP interface for XENAX® Xvi 75V8S, XENAX® Xvi 75V8 and XENAX® Xvi 48V8	XENAX_XVI_75V8S_EtherNetIP.eds XENAX_XVI_75V8_EtherNetIP.eds XENAX_XVI_48V8_EtherNetIP.eds
EtherNet/IP firmware of the bus module	Xenax_EtherNetIP_protocol_Vx.xx.flash

1.3 LED status

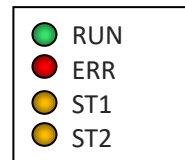

LED state	RUN	ERR	ST1	ST2
<OFF>	In init process or no power			
<ON>	Power on, connected	Fault state	Factory mode, valid application bit stream in the flash. Ready for firmware download	
<Blink>	Power on, not connected	IPv4 address conflict detected	Factory mode, no valid application bit stream in the flash. Ready for bit stream download	Firmware or bit stream download in progress

1.4 IP Configuration

The bus module has its own IP address which is set to DHCP by default. A fixed IP address must be given for proper operation. This can be done with "BootP-DHCP Server". This program creates a DHCP server which gives an IP address to the bus module. BootP-DHCP Server can be downloaded with one of the following links.

https://rockwellautomation.custhelp.com/app/answers/details/a_id/19793/-/bootp-dhcp-ethernet/ip-tool
 or <https://fr.freownloadmanager.org/Windows-PC/BootP-DHCP-Server-GRATUIT.html>

The current IP settings and MAC address can be found in WebMotion.



Start BootP-DHCP Server and set the Subnet Mask which the bus module should get.

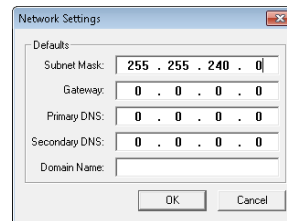

Add the MAC address of the bus module to the relation list. Reset the bus module (chapter 1.5) if its MAC address does not appear.

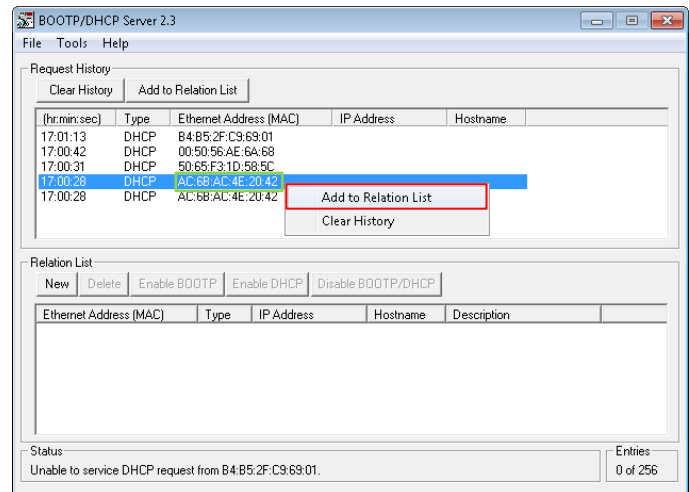

Set the desired IP address.

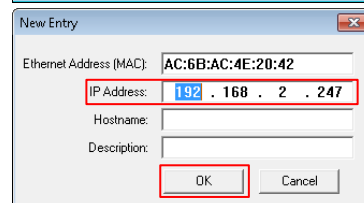

Reset the bus module again and reload the page.
Check if the IP address is set correctly.

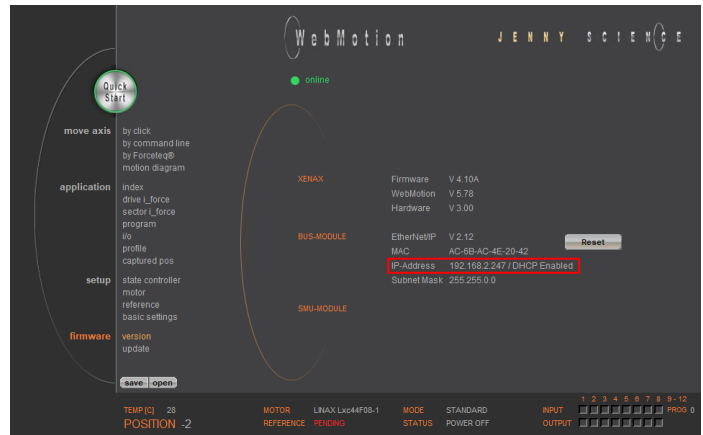

Select the bus module and disable DHCP.
This step might fail, if a PLC is between your PC
and the bus module.

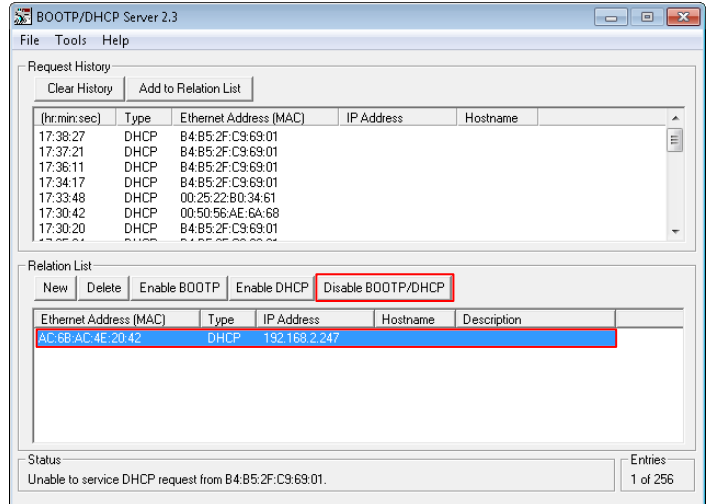

After a reload of Webmotion, DHCP should be disabled.

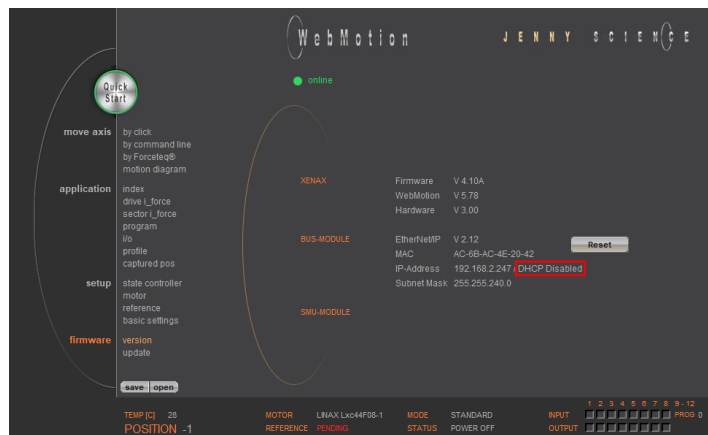

1.5 Factory reset

The communication parameters of the EtherNet/IP bus module can be reset to factory defaults by clicking the “Reset” - button in WebMotion menu

firmware / version-> BUS-MODULE.

In factory defaults, DHCP mode is enabled and the bus module gets its IP-Address from DHCP server.

Address Conflict Detection (ACD) is enabled and the Ethernet ports are configured as followed:

auto negotiation enabled,

Ethernet speed forced to 100MHz,

Ethernet duplex mode forced to full duplex



Communication parameters before reset
(DHCP disabled, static IP Address 192.168.2.249)

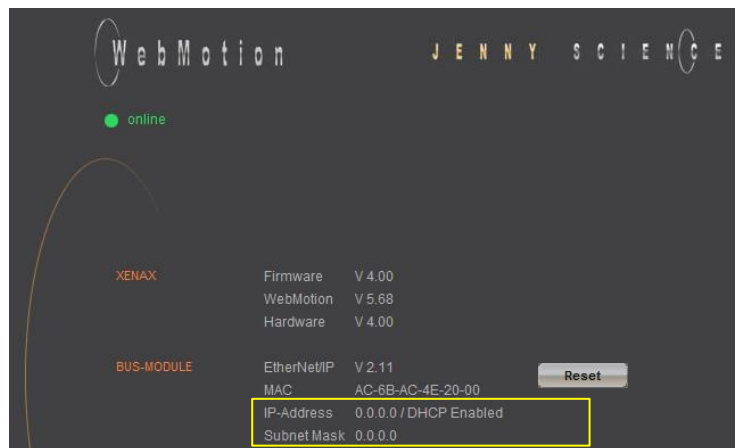

Communication parameters after reset
(DHCP enabled, IP-Address will be get from DHCP server)

2 Messaging over EtherNet/IP

The XENAX[®] servo controller with EtherNet/IP bus module can be controlled over the EtherNet/IP adaptation of CIP (Common Industrial Protocol).

The device uses the device profile “Generic Device” according to CIP specification. Explicit and implicit messaging is supported. Explicit messaging is primary intended to configure XENAX[®] servo controller. Implicit messaging is primary intended for motion control functionality. Over implicit messaging, the servo controller can be controlled in accordance to CANopen DS402 drive profile. See more detailed description in chapter 3.

2.1 Supported features

The XENAX[®] servo controller with EtherNet/IP bus module supports Device Level Ring (DLR) functionality as well as IPv4 Address Conflict Detection (ACD) functionality for EtherNet/IP devices.

For Ethernet communication, DHCP is enabled by default to make communication possible on any network. For final use on a PLC, DHCP has to be disabled and a static IP address has to be used instead of a dynamic IP address for communication with PLC.

2.2 Length

“Set messages” have a source element. Whenever a source element is used, the length in number of bytes of the source element must be specified.

Datatype	Lenght
DINT, UDINT	4
INT, UINT	2
SINT, USINT	1

2.3 Explicit Messaging

2.3.1 Overview

Explicit messaging is primary intended to configure the XENAX[®] servo controller. For explicit messaging, the following standard CIP objects and additional vendor specific objects are supported:

XENAX[®] specific objects:

Class	Object	Details
0x64	XENAX General Parameter Object	See 2.3.1
0x65	XENAX Command Object	See 2.3.2
0x66	XENAX Drive Parameter Object	See 0

Standard CIP objects:

Class	Object	Details
0x01	Identity Object	See 2.3.8
0x02	Message Router Object	See 2.3.10
0x04	Assembly Object	See 2.3.11
0x37	File Object	See 2.3.12
0x47	Device Level Ring Object	See 2.3.13
0x48	QoS Object	See 2.3.14
0xF5	TCP/IP Interface Object	See 2.3.15
0xF6	Ethernet Link Object	See 2.3.16

2.3.2 Status Codes

All supported objects use the general status codes according CIP specification to signal their current status. The vendor specific objects 0x64, 0x65 and 0x66 additionally use vendor specific status codes to signals vendor specific errors. In the following table, the vendor specific error codes are listed.

General Status Code	Status Name	Extended Status Code	Description of status
0x1F	Vendor specific error	0x01	Supported attribute not read- or writable to XENAX®. Possible reasons: <ul style="list-style-type: none"> ⇒ Bus module firmware and XENAX® firmware don't match. See release notes for allowed software configuration. ⇒ Value not valid in current configuration (e.g. set Reference Method to "rotative" with connected linear motor)
0x1F	Vendor specific error	0x02-0xFF	reserved for future use

2.3.1 XENAX General Parameter (0x64)

	Value	Name:				
Services	0x0E	Get_Attributes_Single				
	0x10	Set_Attributes_Single				
Class	0x64					
Instance	0x01					
Attributes						
Id	Name	Data Type	Access Rule	Lower Limit	Default Value	Upper Limit
0x0	SCurve	DINT	Get/Set	0x00000001	0x00000014	0x00000064
0x4	XENAX® Error Number	SINT	Get	0x00	0x00	0x7F
0x5	IForceActual	DINT	Get	0x80000000	0x00000000	0x7FFFFFFF
0x6	ProcessStatusRegisterXENAX	DINT	Get	0x80000000	0x00000000	0x7FFFFFFF
0x7	PDO Cycle Time	UINT	Get/Set	0x00000064	0x000003E8	0x00002710
0x8	Motor Type	STRING	Get	-	-	-
0x9	LimitForce	DINT	Get/Set	0xFFFFCF2C0	0x00000000	0x00030D40
0xA	ForceActual	DINT	Get	0xFFFFCF2C0	0x00000000	0x00030D40

2.3.1.1 SCurve

Description: This parameter indicates the commanded SCurve parameter during the acceleration / deceleration ramp. Unit is [%]. This parameter is used in profile position mode only. This parameter corresponds to the “SCRV” (S-Curve) command, described in the XENAX® servo controller user manual.

2.3.1.2 XENAX Error Number

Description: This parameter represents the error number of the XENAX® servo controller in case of an error. The error number corresponds to the displayed error number at the 7-segment LCD display of the XENAX® servo controller. This parameter corresponds to the “TE” (Tell Error) command, described in the XENAX® servo controller user manual.

2.3.1.3 IForceActual

Description: This parameter represents the force-proportional, actual current-value filtered. Unit is [mA]. This parameter corresponds to the “IFA” (I_Force Actual) command, described in the XENAX® servo controller user manual.

2.3.1.4 ProcessStatusRegisterXENAX

Description: This parameter represents the process status register of the XENAX® servo controller. This parameter corresponds to the “TPSR” (Tell Process Status Register) command, described in the XENAX® servo controller user manual.

2.3.1.5 PDO Cycle Time

Description: This parameter defines the cycle time for cyclic synchronous position mode. Unit is [us] Cyclic synchronous position mode is currently not supported for EtherNet/IP devices. Therefore this parameter is unused. This parameter corresponds to the “PCT” (PDO Cycle Time) command, described in the XENAX[®] servo controller user manual.

2.3.1.6 Motor Type

Description: In case of a connected Jenny Science linear axis, this parameter indicates the type of linear axis connected to the XENAX[®] servo controller. For example an Lxc230F10-1 will return the value “230101” In case of a connected rotative axis, the value “rotative” is returned.

2.3.1.7 LimitForce

Description: This parameter is used for force limitation with over SIGNATEQ[®] connected force sensor (only supported by XENAX[®] Xvi 75V8S). Unit is [mN]. If this parameter has a value other than 0, force limitation is active. If this parameter is 0, force limitation is disabled. This parameter corresponds to the “LF” (Limit Force) command, described in the XENAX[®] servo controller user manual.

2.3.1.8 ForceActual

Description: This parameter represents the actual force value of the over SIGNATEQ[®] connected force sensor (only supported by XENAX[®] Xvi 75V8S). Unit is [mN]. This parameter corresponds to the “FA” (Force Actual) command, described in the XENAX[®] servo controller user manual.

2.3.2 XENAX Command (0x65)

	Value	Name
Services	0x0E	Get_Attributes_Single
	0x10	Set_Attributes_Single
Class	0x65	
Instance	0x01	
Attributes	Id	Name
	0	Direct Commands
	0x1 ... 0xC7	General Commands

This class is used to configure the XENAX[®] servo controller. All commands described in the XENAX[®] servo controller user manual are available as well with attributes of this object class 0x65 (XENAX[®] Command) and can be used to configure the XENAX[®] servo controller. The motion commands of the XENAX[®] servo controller are available as well (for example Attribute ID 0x2B, G: Go Immediately). But for the use with a superior PLC it is strongly recommended to use the parameters in object 0x66 (XENAX[®] Drive Parameter) to perform motion commands accordingly CANopen DS402 drive profile. The DS402 drive profile is described in chapter 3.

2.3.2.1 Direct Command

Attribute ID 0 is used for XENAX® direct commands without any additional parameter. These commands are equivalent to the same named commands described in XENAX® servo controller user manual. Attribute ID 0 is from data type UDINT and settable only. By setting the values described in the following table, the corresponding direct commands are executed:

Value	Command
0x1000	REF: Reference (mandatory for linear axis, optional for rotative axis)
0x1020	RSTO: Limit Stop, mechanical reference for linear axis
0x1030	MLC: Mechanical Limit Calibration
0x1040	Reserved
0x1050	Reserved
0x2000	PW: Power On (for ROTAX® and third party motors only)
0x2010	PWC: Power continues at actual position
0x2020	PWR: Power Reset (reset previous done reference, for test only)
0x2030	PQ: Power Quit
0x3000	GP: Go Position
0x3010	GW: Go Way
0x3020	JP: Jog Positive
0x3030	JN: Jog Negative
0x3040	SM: Stop Motion
0x3050	GZ: Rotate to Z-Mark
0x4000	FC: Force Calibration Drive (distance is parameter WA)
0x4001	FCT1: Force Calibration Test Mode On (with active compensation)
0x4002	FCT0: Force Calibration Test Mode Off (position controller active)
0x4003	FCT2: Force Calibration Test Mode on (without active compensation)
0x4010	IFDCP Automatic I_Force Drift Compensation Drive in positive direction
0x4011	IFDCN Automatic I_Force Drift Compensation Drive in negative direction
0x5000	RES: Reset
0x5001	RESM: Reset Motor Specific Settings
0x5010	CLCP: Clear all Captured Positions
0x5015	CP121: Captured Position Input 12 on
0x5016	CP120: Captured Position Input 12 off
0x5020	CLPO: Clear Position Counter (only rotative motors)
0x6000	Start force monitoring in cyclic synchronous position mode
0x6001	Finish force monitoring in cyclic synchronous position mode. Drive since last start command 0x6000 will be analysed, for example bit 7 in PSR (Force in Sector) gets valid.
0x6002	TPSO Take Position as Sector Offset
0x6010	CLFO Clear Force Offset

2.3.2.2 General Command

Attribute IDs 1-199 are used for general commands. These commands are equivalent to the same named commands described in XENAX® servo controller user manual. The following attribute IDs are supported:

Id	Name	Data Type	Access Rule	Lower Limit	Default Value	Upper Limit
0x2	TS: Tell Status	DINT	Get	0x80000000	0x00000000	0x7FFFFFFF
0x3	TE: Tell Error	DINT	Get	0x80000000	0x00000000	0x7FFFFFFF
0x4	TP: Tell Position	DINT	Get	0x80000000	0x00000000	0x7FFFFFFF
0x5	TT: Tell Temperature	DINT	Get	0x80000000	0x00000000	0x7FFFFFFF
0x6	TOX: Tell Output Hex	DINT	Get	0x80000000	0x00000000	0x7FFFFFFF
0x7	TIX: Tell Input Hex	DINT	Get	0x80000000	0x00000000	0x7FFFFFFF
0x8	TMC: Tell Motor Current	DINT	Get	0x80000000	0x00000000	0x7FFFFFFF
0x9	TMT: Tell Motion Time	DINT	Get	0x80000000	0x00000000	0x7FFFFFFF
0xA	TCP1: Tell Captured Position 1	DINT	Get	0x80000000	0x00000000	0x7FFFFFFF
0xB	TCP2: Tell Captured Position 2	DINT	Get	0x80000000	0x00000000	0x7FFFFFFF
0xC	TCP3: Tell Captured Position 3	DINT	Get	0x80000000	0x00000000	0x7FFFFFFF
0xD	TCP4: Tell Captured Position 4	DINT	Get	0x80000000	0x00000000	0x7FFFFFFF
0xE	TCP5: Tell Captured Position 5	DINT	Get	0x80000000	0x00000000	0x7FFFFFFF
0xF	TCP6: Tell Captured Position 6	DINT	Get	0x80000000	0x00000000	0x7FFFFFFF
0x10	TCP7: Tell Captured Position 7	DINT	Get	0x80000000	0x00000000	0x7FFFFFFF
0x11	TCP8: Tell Captured Position 8	DINT	Get	0x80000000	0x00000000	0x7FFFFFFF
0x12	TH: Tell Reference State	DINT	Get	0x80000000	0x00000000	0x7FFFFFFF
0x13	VER: Version of Firmware	DINT	Get	0x80000000	0x00000000	0x7FFFFFFF
0x14	ACV: Acceleration Variation	DINT	Get	0x80000000	0x00000000	0x7FFFFFFF
0x15	I2TM: Limit Value (scaled to 10)	DINT	Get	0x80000000	0x00000000	0x7FFFFFFF
0x16	I2T: Calculated Value (scaled to 10)	DINT	Get	0x80000000	0x00000000	0x7FFFFFFF
0x17	IFPK: I_Force Peak (FTM = 0) FPK: Force Peak (FTM = 1,2)	DINT	Get	0x80000000	0x00000000	0x7FFFFFFF
0x18	TESM: Tell SMU error	DINT	Get	0x80000000	0x00000000	0x7FFFFFFF
0x19	DGMSO: Detected Gantry Mater Slave Offset	DINT	Get	0x80000000	0x00000000	0x7FFFFFFF
0x1A	SIFF: Sector I_Force Curve Failed (FTM = 0) SFF: Sector Force Curve Failed (FTM = 1,2)	DINT	Get	0x80000000	0x00000000	0x7FFFFFFF
0x1B	IFPKn: I_Force Peak Sector (FTM = 0) FPKn: Force Peak Sector (FTM = 1,2) (select sector with class 0x65, instance 1, attribute 0x78)	DINT	Get	0x80000000	0x00000000	0x7FFFFFFF
0x1C	FCV: Force Calibration Valid	DINT	Get	0x80000000	0x00000000	0x7FFFFFFF
0x1D	TV: Tell Velocity	DINT	Get	0x80000000	0x00000000	0x7FFFFFFF
0x1E	TPT: Tell Process Time	DINT	Get	0x80000000	0x00000000	0x7FFFFFFF
0x1F	VERL: Version of Bootloader	DINT	Get	0x80000000	0x00000000	0x7FFFFFFF

Id	Name	Data Type	Access Rule	Lower Limit	Default Value	Upper Limit
0x20	TCPB Tell Capture Pos.Buffer 1	DINT	Get	0x80000000	0x00000000	0x7FFFFFFF
0x21	TCPB Tell Capture Pos.Buffer 2	DINT	Get	0x80000000	0x00000000	0x7FFFFFFF
0x22	TCPB Tell Capture Pos.Buffer 3	DINT	Get	0x80000000	0x00000000	0x7FFFFFFF
0x23	TCPB Tell Capture Pos.Buffer 4	DINT	Get	0x80000000	0x00000000	0x7FFFFFFF
0x24	TCPB Tell Capture Pos.Buffer 5	DINT	Get	0x80000000	0x00000000	0x7FFFFFFF
0x25	TCPB Tell Capture Pos.Buffer 6	DINT	Get	0x80000000	0x00000000	0x7FFFFFFF
0x26	TCPB Tell Capture Pos.Buffer 7	DINT	Get	0x80000000	0x00000000	0x7FFFFFFF
0x27	TCPB Tell Capture Pos.Buffer 8	DINT	Get	0x80000000	0x00000000	0x7FFFFFFF
0x29	CO: Clear Output Number	DINT	Set	0x00000001	-	0x00000008
0x2A	EVT: Event Activation	DINT	Set	0x00000000	-	0x00000001
0x2B	G: Go Immediately	DINT	Set	0x80000000	-	0x7FFFFFFF
0x2C	IX: Start Index Number	DINT	Set	0x00000001	-	0x00000032
0x2D	PG: Start Program Number	DINT	Set	0x00000001	-	0x0000003F
0x2E	SO: Set Output Number	DINT	Set	0x00000001	-	0x00000008
0x2F	SOX: Set Output Hex Mask	DINT	Set	0x00000000	-	0x000000FF
0x30	TGD: Set Trigger Position Downward	DINT	Set	0x88CA6C00	-	0x77359400
0x31	TGU: Set Trigger Position Upward	DINT	Set	0x88CA6C00	-	0x77359400
0x32	ETI: Event Track Input	DINT	Set	0x00000000	-	0x0000000C
0x33	DTI: Disable Track Input	DINT	Set	0x00000000	-	0x0000000C
0x34	PRF: Start Profile Number	DINT	Set	0x00000001	-	0x00000005
0x35	CRDA: Cogging Reference Drive Automatic	DINT	Set	0x00000000	-	0x7FFFFFFF
0x36	DIF: Drive I_Force	DINT	Set	0x00000001	-	0x0000000A
0x37	CLIF: Change Limit I_Force	DINT	Set	0x00000000	-	0x000007D0
0x38	DF: Drive Force	DINT	Set	0x00000001	-	0x0000000A
0x39	VMTAE: Virtual multiturn for rotative motors with absolute encoder	DINT	Set	0x00000001	0x00000000	0x7FFFFFFF
0x3A	AVF Filter Frequency for Current Shaper	DINT	Get/Set	0x00000000	0x00000000	0x000007D0
0x3B	AVD Damping Ratio for Current Shaper	DINT	Get/Set	0x00000001	0x00000001	0x00000032
0x3C	NOF Preselected output function	DINT	Get/Set	0x00000001	0x00000001	0x00000008
0x3D	TYOF Type of output function	DINT	Get/Set	0x00000000	0x00000000	0x0000000D
0x3E	NIF Preselected input function	DINT	Get/Set	0x00000001	0x00000001	0x00000008
0x3F	TYIF Type of input function	DINT	Get/Set	0x00000000	0x00000000	0x00000016
0x40	PAIF Parameter A of input function	DINT	Get/Set	0x80000000	0x00000000	0x7FFFFFFF
0x41	PBIF Parameter B of input function	DINT	Get/Set	0x80000000	0x00000000	0x7FFFFFFF
0x42	PCIF Parameter C of input function	DINT	Get/Set	0x80000000	0x00000000	0x7FFFFFFF
0x43	CLF Change Limit Force	DINT	Set	0xFFFFCF2C0	0x00000000	0x00030D40

Id	Name	Data Type	Access Rule	Lower Limit	Default Value	Upper Limit
0x44	FDF Force of selected Drive Force	DINT	Get/Set	0xFFFFCF2C0	0x00000000	0x00030D40
0x45	FH Force High	DINT	Get/Set	0xFFFFCF2C0	0x00000000	0x00030D40
0x47	AC: Acceleration	DINT	Get/Set	0x000007D0	0x000F4240	0x3B9ACA00
0x48	S-Curve Profile (in percent)	DINT	Get/Set	0x00000001	0x00000014	0x00000064
0x49	SP: Speed	DINT	Get/Set	0x0000000A	0x000186A0	0x05F5E100
0x4A	PO: Position (absolute)	DINT	Get/Set	0x88CA6C00	0x00000000	0x77359400
0x4B	WA: Way (relative)	DINT	Get/Set	0x88CA6C00	0x00004E20	0x77359400
0x4C	DP: Deviation Position	DINT	Get/Set	0x00000001	0x000007D0	0x000F4240
0x4D	DRHR: Direction Reference	DINT	Get/Set	0x00000000	0x00000000	0x00000005
0x4E	DTP: Deviation Target Position	DINT	Get/Set	0x00000001	0x00000064	0x00002710
0x4F	ED: Emergency Deceleration	DINT	Get/Set	0x00002710	0x00989689	0x3B9ACA00
0x50	ILAS: Input Low Active Selective	DINT	Get/Set	0x00000000	0x00000000	0x00000FFF
0x51	ILA: Input Low Active	DINT	Get/Set	0x00000000	0x00000000	0x00000002
0x52	IS: Stop Current (linear), Nominal Current (rotative), scaled to 10mA	DINT	Get/Set	0x0000000A	-	0x000007D0
0x53	SLPP: Soft Limit Position Positive	DINT	Get/Set	0x80000000	0x00000000	0x7FFFFFFF
0x54	SLPN: Soft Limit Position Negative	DINT	Get/Set	0x80000000	0x00000000	0x7FFFFFFF
0x55	MD: Mode	DINT	Get/Set	0x00000000	0x00000000	0x0000000D
0x56	ML: Mass Load "PAYLOAD"	DINT	Get/Set	0x00000000	0x00000000	0x05F5E100
0x57	BWC: Bandwidth Current Controller "GAIN CUR"	DINT	Get/Set	0x00000005	0x000005DC	0x00001388
0x58	BWP: Bandwidth Position Controller "GAIN POS"	DINT	Get/Set	0x00000001	0x00000032	0x00001388
0x59	IR: Run Current (linear), Torque Current (rotative), scaled to 10mA	DINT	Get/Set	0x0000000A	-	0x000007D0
0x5A	NIX: Preselected Index Number	DINT	Get/Set	0x00000001	0x00000001	0x00000032
0x5B	AIX: Acceleration of selected Index	DINT	Get/Set	0x00000002	0x000003E8	0x000F4240
0x5C	SIX: Speed of selected Index	DINT	Get/Set	0x0000000A	0x000186A0	0x05F5E100
0x5D	DIX: Distance of selected Index	DINT	Get/Set	0x88CA6C00	0x00000000	0x77359400
0x5E	CI: Card Identifier	DINT	Get/Set	0x00000000	0x00000000	0x000000FF
0x5F	GSID: Gantry Slave Identifier	DINT	Get/Set	0x00000000	0x00000000	0x00000004
0x60	BWF1: Bandwidth Filter 1	DINT	Get/Set	0x000001F4	0x00001388	0x000186A0
0x61	FQF1: Frequency Filter 1 "FILTER FREQ"	DINT	Get/Set	0x00000000	0x00000000	0x000007D0
0x62	ICP: Increment per pulse	DINT	Get/Set	0x00000000	0x00000000	0x00000032
0x63	INH: Input Home Sensor	DINT	Get/Set	0x00000001	0x00000001	0x00000008
0x64	OVRD: Speed Override	DINT	Get/Set	0x00000000	0x00000064	0x00000064
0x65	PWRT: Phasing Rotative without HALL	DINT	Get/Set	0x00000000	0x00000000	0x00000001
0x66	SOA: Set Output Activity	DINT	Get/Set	0x00000000	0x000000FF	0x000000FF
0x67	SOT: Set Output Type	DINT	Get/Set	0x00000000	0x00005555	0x0000FFFF
0x68	SR: Synchronous Ratio	DINT	Get/Set	0xFFFFFC18	0x00000000	0x000003E8
0x69	CAB: CAN Baud Rate	DINT	Get	0x00002710	0x0007A120	0x000F4240
0x6A	ROID: Rotative Motor Identifier	DINT	Get	0x00000000	0x00000000	0x7FFFFFFF
0x6B	Reserved	DINT	Get/Set	0x00000000	0x00000000	0x7FFFFFFF
0x6C	Reserved	DINT	Get/Set	0x80000000	0x00000000	0x7FFFFFFF

Id	Name	Data Type	Access Rule	Lower Limit	Default Value	Upper Limit
0x6D	SIFS: Sector I_Force Start (FTM = 0) SFS: Sector Force Start (FTM = 1,2)	DINT	Get/Set	0x88CA6C00	0x00000000	0x77359400
0x6E	SIFE: Sector I_Force End (FTM = 0) SFE: Sector Force End (FTM = 1,2)	DINT	Get/Set	0x88CA6C00	0x00000000	0x77359400
0x6F	IFL: I_Force Low	DINT	Get/Set	0xFFFFF830	0x00000000	0x000007D0
0x70	IFH: I_Force High	DINT	Get/Set	0xFFFFF830	0x00000000	0x000007D0
0x71	MLPN: Mechanical Limit Position Negative	DINT	Get/Set	0x80000000	0x00000000	0x7FFFFFFF
0x72	MLPP: Mechanical Limit Position Positive	DINT	Get/Set	0x80000000	0x00000000	0x7FFFFFFF
0x73	PGMSO: Preset Gantry Master Slave Offset	DINT	Get/Set	0x88CA6C00	0x00000000	0x77359400
0x74	BRKD: Break Delay	DINT	Get/Set	0x00000001	0x00000064	0x000003E8
0x75	Reserved	DINT	Get/Set	0x00000000	0x00000000	0x00000002
0x76	LIF: Limit I_Force	DINT	Get/Set	0x00000000	0x00000000	0x000007D0
0x77	TYIX: Type of Index	DINT	Get/Set	0x00000001	0x00000001	0x00000002
0x78	NSEC: Preselected Sector Number	DINT	Get/Set	0x00000001	0x00000001	0x0000000A
0x79	STCX: Sector Transition Configuration (hex mask)	DINT	Get/Set	0x00000000	0x00000000	0x0000FFFF
0x7A	NDIF: Preselected Drive I_Force Number (FTM = 0) NDF: Preselected Drive Force Number (FTM = 1,2)	DINT	Get/Set	0x00000001	0x00000001	0x0000000A
0x7B	ADIF: Acceleration of selected Drive I_Force (FTM = 0) ADF: Acceleration of selected Drive Force (FTM = 1,2)	DINT	Get/Set	0x00000002	0x000003E8	0x000F4240
0x7C	SDIF: Speed of selected Drive I_Force (FTM = 0) SDF: Speed of selected Drive Force (FTM = 1,2)	DINT	Get/Set	0x0000000A	0x000186A0	0x05F5E100
0x7D	IDIF: I_Force Limit of selected Drive I_Force	DINT	Get/Set	0x00000001	0x00000001	0x000007D0
0x7E	DDIF: Direction of selected Drive I_Force (FTM = 0) DDF: Direction of selected Drive Force (FTM = 1,2)	DINT	Get/Set	0x00000000	0x00000000	0x00000001
0x7F	SSEC: Select Sectors (binary notation, LSB = sector 1)	DINT	Get/Set	0x00000000	0x00000001	0x000003FF
0x80	SSO: Set Sector Offset	DINT	Get/Set	0x80000000	0x00000000	0x7FFFFFFF
0x81	ENCPD: Encoder Plausibility Checking Disable	DINT	Get/Set	0x00000000	0x00000000	0x00000001
0x82	SPAD: Set Point ACK disable	DINT	Get/Set	0x00000000	0x00000000	0x00000001
0x83	RXZP Rotax Z-Position	DINT	Get/Set	0x00000000	0x00000000	0x00000000
0x84	DRH Dir Home	DINT	Get/Set	0x00000001	0x00000001	0x00000002
0x85	DRZ Z-Mark	DINT	Get/Set	0x00000001	0x00000001	0x00000003
0x86	FQS Filter Quality Speed	DINT	Get/Set	0x000001F7	0x00001388	0x000186A0
0x87	FFS Filter Frequency Speed	DINT	Get/Set	0x00000000	0x00000000	0x000007D0
0x88	EBMD Enhanced Bandwidth Mode Disabled	DINT	Get/Set	0x00000000	0x00000000	0x00000001

Id	Name	Data Type	Access Rule	Lower Limit	Default Value	Upper Limit
0x89	Reserved	DINT	Get/Set	0x00000000	0x00000000	0x000003E8
0x8A	AIXD Acceleration of selected dynamically Index	DINT	Get/Set	0x00000002	0x000003E8	0x000F4240
0x8B	SIXD Speed of selected dynamically Index	DINT	Get/Set	0x0000000A	0x000186A0	0x05F5E100
0x8C	DIXD Distance of selected dynamically Index (depends on absolute or relative index definition)	DINT	Get/Set	0x88CA6C00	0x00000000	0x77359400
0x8D	TYIXD Type of dynamically Index	DINT	Get/Set	0x00000001	0x00000001	0x00000002
0x8E	PPSD Pole Placement Stability Dynamics	DINT	Get/Set	0xFFFFFCE	0x00000003	0x00000032
0x8F	IFDCS I_Force Drift Compensation Setting	DINT	Get/Set	0x00000000	0x00000000	0x00000007
0x90	Reserved	DINT	Get/Set	0x80000000	0x00000000	0x7FFFFFFF
0x91	SORF Swing Out Reduction Frequency	DINT	Get/Set	0x00000000	0x00000000	0x000003E8
0x92	SORD Swing Out Reduction Damping	DINT	Get/Set	0x00000000	0x00000000	0x00000032
0x93	Reserved	DINT	Get/Set	0x00000000	0x00000000	0x00000001
0x94	Reserved	DINT	Get/Set	0x00000000	0x00000000	0x00000001
0x95	EGMSO Enable user defined gantry Master/Slave offset	DINT	Get/Set	0x00000000	0x00000001	0x00000001
0x97	POL: Pole Pairs	DINT	Get/Set	0x00000000	0x00000000	0x00000064
0x98	ENC: Encoder Increments	DINT	Get/Set	0x0000000A	0x00005DC0	0x00989680
0x99	PHD: Phase Direction	DINT	Get/Set	0x00000000	0x00000000	0x00000001
0x9A	PHO: Phase Offset	DINT	Get/Set	0x00000000	0x00000000	0x00000167
0x9B	MAMO: Mass Motor (linear), Rotor Inertia (rotative)	DINT	Get/Set	0x00000000	-	0x00989680
0x9C	FCM: Force Constant of Motor	DINT	Get/Set	0x00000000	-	0x05F5E100
0x9D	LPH: Inductance Phase-Phase	DINT	Get/Set	0x00000000	-	0x000186A0
0x9E	RPH: Resistance Phase-Phase	DINT	Get/Set	0x00000000	-	0x000186A0
0x9F	FFDY: Friction Force Dynamic	DINT	Get/Set	0x00000000	-	0x00002710
0xA0	FFST: Friction Force Static	DINT	Get/Set	0x00000000	-	0x00002710
0xA1	DMLPP: Detected Mechanical Position Positive	DINT	Get/Set	0x00000000	0x00000000	0x7FFFFFFF
0xA4	AREF Automatic Reference	DINT	Get/Set	0x00000000	0x00000000	0x00000001
0xA5	TESMH: Tell SMU error History	DINT	Get	0x80000000	0x00000000	0x7FFFFFFF
0xA6	GR: Gear Ratio	DINT	Get	0x80000000	0x00000000	0x7FFFFFFF
0xA7	TTPS: Tell Temperature Power Stage (Xvi75V8S only)	DINT	Get	0x80000000	0x00000000	0x7FFFFFFF
0xA8	TVPSM Tell voltage power supply motor in [mV]	DINT	Get	0x80000000	0x00000000	0x7FFFFFFF
0xAB	VERS: Version SMU	DINT	Get	0x80000000	0x00000000	0x7FFFFFFF
0xAC	SLS: Timeout SMU	DINT	Get	0x80000000	0x00000000	0x7FFFFFFF
0xAD	Speed Limit SMU	DINT	Get	0x80000000	0x00000000	0x7FFFFFFF
0xAE	Stop Timeout SMU	DINT	Get	0x80000000	0x00000000	0x7FFFFFFF
0xAF	Position Window SMU	DINT	Get	0x80000000	0x00000000	0x7FFFFFFF
0xB0	SFTRD: Input Configuration SMU	DINT	Get	0x80000000	0x00000000	0x7FFFFFFF
0xB1	TESM: Tell SMU error	DINT	Get	0x80000000	0x00000000	0x7FFFFFFF
0xB2	SMU Master Error Bitfield	DINT	Get	0x80000000	0x00000000	0x7FFFFFFF
0xB3	SMU Slave Error Bitfield	DINT	Get	0x80000000	0x00000000	0x7FFFFFFF

Id	Name	Data Type	Access Rule	Lower Limit	Default Value	Upper Limit
0xB4	SMU Master Info Bitfield	DINT	Get	0x80000000	0x00000000	0x7FFFFFFF
0xB5	SMU Slave Error Bitfield	DINT	Get	0x80000000	0x00000000	0x7FFFFFFF
0xBA	EGW: Set Gateway Address	DINT	Get/Set	0x80000000	0xC0A80201	0x7FFFFFFF
0xBB	EIP Set IP Address	DINT	Get/Set	0x80000000	0xC0A80264	0x7FFFFFFF
0xBC	ENM Set Net Mask	DINT	Get/Set	0x80000000	0xFFFFC00	0x7FFFFFFF
0xBD	EMAC Read MAC Address 3 high Bytes	DINT	Get	0x80000000	0x00000000	0x7FFFFFFF
0xBE	EMAC Read MAC Address 3 low Bytes	DINT	Get	0x80000000	0x00000000	0x7FFFFFFF
0xBF	EPRT Set Port Number	DINT	Get/Set	0x00000001	0x00002711	0x0000FFFF
0xC0	LICR Show Installed Licences	DINT	Get	0x80000000	0x00000000	0x7FFFFFFF
0xC1	SERB Set Baud Rate on Serial Interface	DINT	Get/Set	0x00002580	0x0001C200	0x00054600
0xC2	WebMotion Version	DINT	Get	0x80000000	0x00000000	0x7FFFFFFF
0xC3	WebMotion Boot Version	DINT	Get	0x80000000	0x00000000	0x7FFFFFFF
0xC4	FL Force Low	DINT	Get/Set	0xFFFCF2C0	0x00000000	0x00030D40
0xC5	FTM Forceteq Mode	DINT	Get/Set	0x00000000	0x00000000	0x00000002
0xC6	SQBW Signateq Bandwidth	DINT	Get/Set	0x00000064	0x000001F4	0x00001388
0xC7	MM Motor Manufacturer	DINT	Get/Set	0x00000000	0x00000000	0x00000002

2.3.4 XENAX Drive Parameter (0x66)

	Value	Name:				
Services	0x0E	Get_Attributes_Single				
	0x10	Set_Attributes_Single				
Class	0x66					
Instance	0x01					
Attributes						
Id	Name	Data Type	Access Rule	Lower Limit	Default Value	Upper Limit
0x00	Controlword	INT	Get/Set	0x8000	0x0000	0x7FFF
0x01	Statusword	INT	Get	0x8000	0x0000	0x7FFF
0x20	Modes of operation requested	SINT	Get/Set	0xFE	0x00	0x08
0x21	Modes of operation displayed	SINT	Get	0xFE	0x00	0x08
0x24	PositionActualValue	DINT	Get	0x80000000	0x00000000	0x7FFFFFFF
0x25	FollowingPositionErrorWindow	DINT	Get/Set	0x00000001	0x000007D0	0x000F4240
0x27	TargetPositionWindow	DINT	Get/Set	0x00000001	0x00000064	0x00002710
0x28	TargetPositionWindowTime	DINT	Get/Set	0x00000000	0x00000000	0x000003E8
0x33	LimitIForce	INT	Get/Set	0x0000	0x0000	0x0708
0x38	MotorCurrentActualValue	INT	Get	0x8000	0x0000	0x7FFF
0x3A	TargetPositionOrDistance	DINT	Get/Set	0x80000000	0x00000000	0x7FFFFFFF
0x3E	Software Position Limit Negative	DINT	Get/Set	0x80000000	0x00000000	0x7FFFFFFF
0x3F	Software Position Limit Positive	DINT	Get/Set	0x80000000	0x00000000	0x7FFFFFFF
0x41	SpeedJogOrProfilePositionMode	DINT	Get/Set	0x0000000A	0x000186A0	0x05F5E100
0x43	AccelerationJogOrProfilePositionMode	DINT	Get/Set	0x000007D0	0x000F4240	0x3B9ACA00
0x45	Deceleration, Quick Stop	UDINT	Get/Set	0x00002710	0x000	0x3B9ACA00
0x58	Reference Methods	SINT	Get/Set	0x01	0x01	0x0D
0x5A	Reference-Speed for external reference sensor	UDINT	Get/Set	0x00000000	0x000003E8	0x0003D090
0x5B	Reference-Speed for internal Z-Mark	UDINT	Get/Set	0x00000000	0x000001F4	0x000186A0
0xB4	ActualPositionFollowingError	DINT	Get	0x80000000	0x00000000	0x7FFFFFFF
0xBD	DigitalInputsXENAX	DINT	Get	0x80000000	0x00000000	0x7FFFFFFF
0xBF	DigitalOutputsXENAX	DINT	Get/Set	0x80000000	0x00000000	0x7FFFFFFF
0xC3	Supported Modes of Operation	UDINT	Get	0x000100A1	0x000100A1	0x000100A1
0xC6	Product Website Address	STRING	Get	-	-	-

This class is used to configure the XENAX® drive parameters. The XENAX® drive parameters are in accordance with CANopen DS402 drive protocol and can be used to control the XENAX® servo controller accordingly to the DS402 drive profile, described chapter 3. It is strongly recommended to use the parameters of this object class (0x66) for motion control functionality accordingly to the DS402 drive profile. The most important parameters of this object class are as well available in the various assemblies described in chapter 2.4 for fast cyclic access.

2.3.4.1 Controlword

Id	Name	Data Type	Access Rule	Lower Limit	Default Value	Upper Limit
0x00	Controlword	INT	Get/Set	0x8000	0x0000	0x7FFF

Description: This parameter represents the CANopen DS402 controlword to move the axis according DS402 device profile. See description of DS402 state machine in chapter 3.1 for further explanation. The DS402 controlword is organized bit-wise as follows:

Bit 0	switch on
Bit 1	enable voltage
Bit 2	quick stop (switch off power)
Bit 3	enable operation
Bit 4	Reference start (Reference mode) New Position (Profile position mode) Start moving (Cyclic synchronous position mode)* Start Jog drive (Jog mode)
Bit 5	not used
Bit 6	(Profile position mode) 0: Absolute Position 1: Relative Distance (Jog mode) 0: Direction negative 1: Direction positive
Bit 7	fault reset
Bit 8	Halt (usable in motion only)
Bit 9	operation mode-specific
Bit 10	reserved
Bit 11-15	manufacturer-specific

Command	Bits of the controlword					Transitions
	Bit 7	Bit 3	Bit 2	Bit 1	Bit 0	
Shutdown	0	X	1	1	0	2,6,8
Switch on	0	0	1	1	1	3
Switch on + enable operation	0	1	1	1	1	3 + 4 (NOTE)
Disable voltage	0	X	X	0	X	7,9,10,12
Quick stop	0	X	0	1	X	7,10,11
Disable operation	0	0	1	1	1	5
Enable operation	0	1	1	1	1	4,16
Fault reset		X	X	X	X	15

NOTE Automatic transition to Enable operation state after executing SWITCHED ON state functionality.

* Cyclic synchronous position mode not supported.

2.3.4.2 Statusword

Id	Name	Data Type	Access Rule	Lower Limit	Default Value	Upper Limit
0x01	Statusword	INT	Get	0x8000	0x0000	0x7FFF

Description: This parameter represents the CANopen DS402 statusword to move the axis according DS402 device profile. See description of DS402 state machine in chapter 3.1 for further explanation. The DS402 statusword is organized bit-wise as follows:

Bit 0	ready to switch on
Bit 1	switched on
Bit 2	operation enabled
Bit 3	fault
Bit 4	voltage enabled
Bit 5	quick stop
Bit 6	switch on disabled
Bit 7	warning
Bit 8	manufacturer-specific
Bit 9	remote
Bit 10	(Profile position mode) target position reached (Jog mode) constant speed reached
Bit 11	Soft-Limit position reached
Bit 12	Reference achieved (Reference mode) Acknowledge of moving to target position (Profile Position Mode) Target position (Cyclic synchronous position mode) Speed is equal 0 (Jog mode)
Bit 13	Reference error (Reference mode) Following position error (Profile Position Mode/ Cyclic Synchronous Position Mode/ Jog Mode)
Bit 14-15	manufacturer-specific

Statusword	PDS FSA state
xxxx xxxx x0xx 0000 _b	Not ready to switch on
xxxx xxxx x1xx 0000 _b	Switch on disabled
xxxx xxxx x01x 0001 _b	Ready to switch on
xxxx xxxx x01x 0011 _b	Switched on
xxxx xxxx x01x 0111 _b	Operation enabled
xxxx xxxx x00x 0111 _b	Quick stop active
xxxx xxxx x0xx 1111 _b	Fault reaction active
xxxx xxxx x0xx 1000 _b	Fault

2.3.4.3 Modes of operation requested

Id	Name	Data Type	Access Rule	Lower Limit	Default Value	Upper Limit
0x20	Modes of operation requested	SINT	Get/Set	0xFE	0x00	0x08

Description: This parameter contains the value of the requested mode of operation. The actual mode of operation is shown in the parameter “Modes of operation displayed”. The following value definitions are valid:

-2	XENAX® specific, not used
-1	Jog mode Jenny Science specific
0	no mode change / no mode assigned
1	profile position mode
6	reference mode
8	cyclic synchronous position mode*

*Cyclic synchronous position mode not supported

2.3.4.4 Modes of operation displayed

Id	Name	Data Type	Access Rule	Lower Limit	Default Value	Upper Limit
0x21	Modes of operation displayed	SINT	Get	0xFE	0x00	0x08

Description: This parameter shows the actual mode of operation. The following value definitions are valid:

-2	XENAX® specific, not used
-1	Jog mode Jenny Science specific
0	no mode change / no mode assigned
1	profile position mode
6	reference mode
8	cyclic synchronous position mode*

*Cyclic synchronous position mode not supported

2.3.4.5 PositionActualValue

Id	Name	Data Type	Access Rule	Lower Limit	Default Value	Upper Limit
0x24	PositionActualValue	DINT	Get	0x80000000	0x00000000	0x7FFFFFFF

Description: This parameter shows the actual absolute position value of the XENAX® internal encoder counter. Unit is [increment]. This parameter corresponds to the “TP” (Tell Position) command, described in the XENAX® servo controller user manual.

2.3.4.6 FollowingPositionErrorWindow

Id	Name	Data Type	Access Rule	Lower Limit	Default Value	Upper Limit
0x25	FollowingPositionErrorWindow	DINT	Get/Set	0x00000001	0x000007D0	0x000F4240

Description: This parameter defines the range of tolerated position values symmetrical to the trajectory. Unit is [increment]. This parameter corresponds to the “DP” (Deviation Position) command, described in the XENAX® servo controller user manual.

2.3.4.7 TargetPositionWindow

Id	Name	Data Type	Access Rule	Lower Limit	Default Value	Upper Limit
0x27	TargetPositionWindow	DINT	Get/Set	0x00000001	0x00000064	0x00002710

Description: This parameter sets the symmetrical tolerance of position corresponding to the target position. Unit is [increment]. If the actual value of the position encoder is within the tolerance, the corresponding status bit says the target position is reached. This parameter corresponds to the “DTP” (Deviation Target Position) command, described in the XENAX® servo controller user manual.

2.3.4.8 LimitIForce

Id	Name	Data Type	Access Rule	Lower Limit	Default Value	Upper Limit
0x33	LimitIForce	INT	Get/Set	0x0000	0x0000	0x07D0

Description: This parameter is used for motor current limitation. Unit is [10xmA]. If this parameter has a value other than 0, the motor current is limited to this value. If this parameter is 0, I_Force limitation is disabled. This parameter corresponds to the “LIF” (Limit I_Force) command, described in the XENAX® servo controller user manual.

2.3.4.9 MotorCurrentActualValue

Id	Name	Data Type	Access Rule	Lower Limit	Default Value	Upper Limit
0x38	MotorCurrentActualValue	INT	Get	0x8000	0x0000	0x7FFF

Description: This parameter represents the force-proportional, actual motor current (unfiltered). Unit is [mA]. This parameter corresponds to the “TMC” (Tell Motor Current) command, described in the XENAX® servo controller user manual.

2.3.4.10 TargetPositionOrDistance

Id	Name	Data Type	Access Rule	Lower Limit	Default Value	Upper Limit
0x3A	TargetPositionOrDistance	DINT	Get/Set	0x80000000	0x00000000	0x7FFFFFFF

Description: This parameter is used as absolute position or relative distance depending on bit 6 of the controlword in profile position mode. Unit is [increment]. This parameter corresponds to the “PO” (Position) command, described in the XENAX® servo controller user manual.

2.3.4.11 Software Position Limit Negative

Id	Name	Data Type	Access Rule	Lower Limit	Default Value	Upper Limit
0x3E	Software Position Limit Negative	DINT	Get/Set	0x80000000	0x00000000	0x7FFFFFFF

Description: This parameter corresponds to the limitation driveway negative. Unit is [increment]. This parameter corresponds to the “SLPN” (Soft Limit Position Negative) command, described in the XENAX® servo controller user manual.

2.3.4.12 Software Position Limit Positive

Id	Name	Data Type	Access Rule	Lower Limit	Default Value	Upper Limit
0x3F	Software Position Limit Positive	DINT	Get/Set	0x80000000	0x00000000	0x7FFFFFFF

Description: This parameter corresponds to the limitation driveway positive. Unit is [increment]. This parameter corresponds to the “SLPP” (Soft Limit Position Positive) command, described in the XENAX® servo controller user manual.

2.3.4.13 SpeedJogOrProfilePositionMode

Id	Name	Data Type	Access Rule	Lower Limit	Default Value	Upper Limit
0x41	SpeedJogOrProfilePositionMode	DINT	Get/Set	0x0000000A	0x000186A0	0x05F5E100

Description: This parameter sets the speed for profile position mode. Unit is [increment/s]. This parameter corresponds to the “SP” (Speed) command, described in the XENAX® servo controller user manual.

2.3.4.14 AccelerationJogOrProfilePositionMode

Id	Name	Data Type	Access Rule	Lower Limit	Default Value	Upper Limit
0x43	AccelerationJogOrProfilePositionMode	DINT	Get/Set	0x000007D0	0x000F4240	0x3B9ACA00

Description: This parameter sets the acceleration for profile position mode. Unit is [increment/s²]. This parameter corresponds to the “AC” (Acceleration) command, described in the XENAX® servo controller user manual.

2.3.4.15 Deceleration, Quick Stop

Id	Name	Data Type	Access Rule	Lower Limit	Default Value	Upper Limit
0x45	Deceleration, Quick Stop	UDINT	Get/Set	0x00002710	0x000	0x3B9ACA00

Description: This parameter sets the deceleration used for quick stop, if requested in controlword. Unit is [increment/s²]. This parameter corresponds to the “ED” (Emergency Deceleration) command, described in the XENAX® servo controller user manual.

2.3.4.16 Reference Methods

Id	Name	Data Type	Access Rule	Lower Limit	Default Value	Upper Limit
0x58	Reference Methods	SINT	Get/Set	0x01	0x01	0x0D

Description: The reference methods are divided in two separate procedures. For linear motors, the reference must be always the first initial function. Rotative motors may be run without reference. The following value definitions are valid:

LINAX® liner motor axes	
1	REFERENCE, start direction positive
2	REFERENCE, start direction negative
3	REFERENCE, gantry system, direction positive, linear motor axes same measurement system orientation
4	REFERENCE, gantry system, direction negative, linear motor axes same measurement system orientation
5	REFERENCE, gantry system, direction positive, linear motors axes contrary measurement system orientation
6	REFERENCE, gantry system, direction negative, linear motors axes contrary measurement system orientation
Rotative motors	
10	REFERENCE, start clockwise -> external reference Sensor, continue counter clockwise -> Z-mark
11	REFERENCE, start clockwise -> external reference Sensor, continue clockwise -> Z-mark
12	REFERENCE, start counter clockwise -> external reference Sensor, continue counter clockwise -> Z-mark
13	REFERENCE, start, counter clockwise -> external reference Sensor, continue clockwise -> Z-mark
14	REFERENCE, start clockwise -> external reference Sensor, shortest way -> Z-mark only for ROTAX® Rxvp
15	REFERENCE, start counter clockwise -> external reference Sensor, shortest way -> Z-mark only for ROTAX® Rxvp

2.3.4.17 Reference-Speed for external reference sensor

Id	Name	Data Type	Access Rule	Lower Limit	Default Value	Upper Limit
0x5A	Reference-Speed for external reference sensor	UDINT	Get/Set	0x00000000	0x000003E8	0x0003D090

Description: This parameter sets the reference speed to search the external reference sensor. Unit is [increment/s]. If there is no external reference sensor, set reference speed to 0. This parameter corresponds to the “SPH” (Speed Home) command, described in the XENAX® servo controller user manual.

2.3.4.18 Reference-Speed for internal Z-Mark

Id	Name	Data Type	Access Rule	Lower Limit	Default Value	Upper Limit
0x5B	Reference-Speed for internal Z-Mark	UDINT	Get/Set	0x00000000	0x000001F4	0x000186A0

Description: This parameter sets the speed to search the internal Z-mark. Unit is [increment/s]. If there is no internal Z-mark, then set Z-mark speed to 0. This parameter corresponds to the “SPZ” (Speed Z-Mark) command, described in the XENAX® servo controller user manual.

2.3.4.19 ActualPositionFollowingError

Id	Name	Data Type	Access Rule	Lower Limit	Default Value	Upper Limit
0xB4	ActualPositionFollowingError	DINT	Get	0x80000000	0x00000000	0x7FFFFFFF

Description: This parameter is the actual deviation between the calculated trajectory position and the measured position on encoder. Unit is [increment].

2.3.4.20 DigitalInputsXENAX

Id	Name	Data Type	Access Rule	Lower Limit	Default Value	Upper Limit
0xBD	DigitalInputsXENAX	DINT	Get	0x80000000	0x00000000	0x7FFFFFFF

Description: This parameter contains the status of digital inputs on the XENAX[®] servo controller.
 Bit value = 0: input is Low; Bit value = 1: input is High.

The inputs 1-8 are bit coded to the bits 16-23 of the parameter.

2.3.4.21 DigitalOutputsXENAX

Id	Name	Data Type	Access Rule	Lower Limit	Default Value	Upper Limit
0xBF	DigitalOutputsXENAX	DINT	Get/Set	0x80000000	0x00000000	0x7FFFFFFF

Description: This parameter controls the digital output signals of the XENAX[®] servo controller.
 Bit value = 0: output is logic 0; Bit value = 1: output is logic 1. The physical output level can be set-up for every output bit individual (Sink, Source or Sink&Source). See XENAX[®] servo controller user manual for detailed description.

The outputs 1-8 are bit coded to the bits 16-23 of the parameter.

2.3.4.22 Supported Modes of Operation

Id	Name	Data Type	Access Rule	Lower Limit	Default Value	Upper Limit
0xC3	Supported Modes of Operation	UDINT	Get	0x000100A1	0x000100A1	0x000100A1

Description: This parameter shows the supported modes of operation.
 Bit value = 0: Mode is not supported; Bit value 1: Mode is supported

Bit 0	profile position mode	1
Bit 1	speed mode	0
Bit 2	profile speed mode	0
Bit 3	profile torque mode	0
Bit 4	reserved	0
Bit 5	reference mode	1
Bit 6	interpolated position mode	0
Bit 7	cyclic synchronous position mode	1
Bit 8	cyclic synchronous speed mode	0
Bit 9	cyclic synchronous torque mode	0
Bit 10-15	reserved	0
Bit 16	jog mode (Jenny Science specific)	1
Bit 17	reserved (Jenny Science specific)	0
Bit 18-31	manufacturer-specific	-

2.3.4.23 Product Website Address

Id	Name	Data Type	Access Rule	Lower Limit	Default Value	Upper Limit
0xC6	Product Website Address	STRING	Get	-	-	-

Description: This parameter indicates the assigned web address of the drive manufacturer
 “<http://www.jennyscience.ch>”

2.3.5 XENAX Drive Parameter (0x67)

	Value	Name:				
Services	0x0E	Get_Attributes_Single				
	0x10	Set_Attributes_Single				
Class	0x67					
Instance	0x01					
Attributes						
Id	Name	Data Type	Access Rule	Lower Limit	Default Value	Upper Limit
0x01	LARES linear axis resolution in [inc/m]	INT	Get	0x8000	0x0000	0x7FFF
0x02	LAST linear axis stroke in [inc]	INT	Get	0x8000	0x0000	0x7FFF
0x03	TTGS Tell trajectory state	INT	Get	0x8000	0x0000	0x7FFF

This class contains all CANopen parameters from object 0x5001 with subindex 43 and higher.

2.3.6 XENAX Drive Parameter (0x68)

	Value	Name:				
Services	0x0E	Get_Attributes_Single				
	0x10	Set_Attributes_Single				
Class	0x67					
Instance	0x01					
Attributes						
Id	Name	Data Type	Access Rule	Lower Limit	Default Value	Upper Limit
0x01	ENAR Enable absolute reference	INT	Get/Set	0x0	0x0000	0x1
0x02	CTAB Correction Table State	INT	Get/Set	0x0	0x0000	0x1
0x03	APSN number of the program to auto start	INT	Get/Set	0x0	0x0000	0x3F
0x04	APSD Automatic program start delay in ms	INT	Get/Set	0x0	0x0000	0xFFFF
0x05	PMHSD Profinet MC_Home support disable	INT	Get/Set	0x0	0x0	0x1
0x06	FCSM Force Calibration Storage mode	INT	Get/Set	0x0	0x0	0x1
0x07	SOD P402 Switch on at transition 3 disable	INT	Get/Set	0x0	0x0	0x1
0x08	GCME Gantry Coupled Mode enable	INT	Get/Set	0x0	0x1	0x1
0x09	FBCM Force buffered CSP mode	INT	Get/Set	0x0	0x0	0x1

This class contains all CANopen parameters from object 0x5003 with subindex 98 and higher.

2.3.7 XENAX Drive Parameter (0x69)

	Value	Name:				
Services	0x0E	Get_Attributes_Single				
	0x10	Set_Attributes_Single				
Class	0x67					
Instance	0x01					
Attributes						
Id	Name	Data Type	Access Rule	Lower Limit	Default Value	Upper Limit
0x01	TES Tell Error String (100)	STRING	Get	-	-	-
0x02	SID servo identification string (32)	STRING	Get/Set	-	-	-

This class contains all CANopen parameters objects 0x5020-0x5029.

2.3.8 Forceteq pro Parameter (0x6E)

	Value	Name:				
Services	0x0E	Get_Attributes_Single				
	0x10	Set_Attributes_Single				
Class	0x6E					
Instance	0x01					
Attributes						
Id	Name	Data Type	Access Rule	Lower Limit	Default Value	Upper Limit
0x0	Signateq Firmware Version	DINT	Get	0x80000000	0x00000000	0x7FFFFFFF
0x1	Signateq Bandwith	DINT	Get/Set	0x00000064	0x000001F4	0x00001388
0x2	Signateq Sensor Nominal Force	DINT	Get/Set	0x00000000	0x00000000	0x00030D40
0x3	Signateq Measurement Range Positive	DINT	Get/Set	0xFFFFCF2C0	0x00000000	0x00030D40
0x4	Signateq Measurement Range Negative	DINT	Get/Set	0xFFFFCF2C0	0x00000000	0x00030D40
0x5	Signateq Sensor Sensitivity	DINT	Get/Set	0x00000000	0x00000000	0x017D7840
0x6	Signateq Sensor Force Type	DINT	Get/Set	0x00000000	0x00000000	0x00000002
0x7	Signateq Operation Mode	DINT	Get/Set	0x00000000	0x00000000	0x00000002
0x8	Signateq Force Direction	DINT	Get/Set	0x00000000	0x00000000	0x00000002
0x9	Limit Force Reached Maximum Speed	DINT	Get/Set	0x00000000	0x00002710	0x00895440
0xA	CLFO Clear Force Offset	DINT	Get/Set	0x00000000	0x00000000	0x00000001
0xB	SQAC Signateq Available Calibrations	DINT	Get/Set	0x00000000	0x00000000	0x00000007
0xC	BWFP Bandwidth for forceteq pro controller	DINT	Get/Set	0x00000001	0x00000032	0x000003E8
0xD	FTPES Forceteq Pro Elastic Spring Constant	DINT	Get/Set	0x00000001	0x000003E8	0x00989680
0x64	Signateq Sensor Model Type (30)	STRING	Get/Set	-	-	-
0x65	Signateq Sensor Serial Number (30)	STRING	Get/Set	-	-	-

Description: This parameter are only accessible on XENAX Xvi 75V8S with Signateq®.

2.3.9 Identity (0x01)

	Value	Name		
Services	0x0E	Get_Attributes_Single		
Class	0x01			
Instance	0x01			
Attributes	Id	Name	Data Type	Access Rule
	0x1	Vendor ID	UINT	Get
	0x2	Device Type	UINT	Get
	0x3	Product Code	UINT	Get
	0x4	Revision	USINT[2]	Get
	0x5	Status	WORD	Get
	0x6	Serial Number	UDINT	Get
	0x7	Product Name	SHORT_STRING	Get

Description: For detailed description of all attributes, see CIP specification. Following, only the most important attribute values are listed:

XENAX® Xvi 75V8S:

Vendor ID: 1389 (Jenny Science AG)
 Device Type: 43 (Generic Device)
 Product Code: 0x7509
 Product Name: XENAX Xvi 75V8S

XENAX® Xvi 75V8:

Vendor ID: 1389 (Jenny Science AG)
 Device Type: 43 (Generic Device)
 Product Code: 0x7508
 Product Name: XENAX Xvi 75V8

XENAX® Xvi 48V8:

Vendor ID: 1389 (Jenny Science AG)
 Device Type: 43 (Generic Device)
 Product Code: 0x4808
 Product Name: XENAX Xvi 48V8

2.3.10 Message Router (0x02)

	Value	Name		
Services	-	-		
Class	0x02			
Instance	0x01			
Attributes	Id	Name	Data Type	Access Rule
	-	-	-	-

Description: For detailed description of the attributes, see CIP specification.

2.3.11 Assembly (0x04)

	Value	Name		
Services	0x0E	Get_Attributes_Single		
	0x10	Set_Attributes_Single		
Class	0x04			
Instance	0x01			
Attributes	Id	Name	Data Type	Access Rule
	0x3	Data	USINT[]	Get/Set

Description: For detailed description of the attributes, see CIP specification.

2.3.12 File (0x37)

	Value	Name		
Services	0x0E	Get_Attributes_Single		
	0x4B	Initiate_Upload		
	0x4F	Upload_Transfer		
Class	0x37			
Instance	0x01			
Attributes	Id	Name	Data Type	Access Rule
	0x1	State	USINT	Get
	0x2	Instance Name	STRINGI	Get
	0x3	File Format Version	UINT	Get
	0x4	File Name	STRINGI	Get
	0x5	File Revision	USINT[2]	Get
	0x6	File Size	UDINT	Get
	0x7	File Checksum	UINT	Get
	0x8	Invocation Method	USINT	Get
	0x9	File Save Parameters	BYTE	Get
	0xA	File Access Rule	USINT	Get
	0xB	File Encoding Format	USINT	Get

2.3.13 Device Level Ring (0x47)

	Value	Name		
Services	0x0E	Get_Attributes_Single		
	0x01	Get_Attributes_All		
Class	0x47			
Instance	0x01			
Attributes	Id	Name	Data Type	Access Rule
	0x1	Network Topology	USINT	Get
	0x2	Network Status	USINT	Get
	0xA	Active Supervisor Address	UDINT+USINT[6]	Get
	0xC	Capability Flags	DWORD	Get

2.3.14 QoS (0x48)

	Value	Name		
Services	0x0E	Get_Attributes_Single		
	0x10	Set_Attributes_Single		
Class	0x48			
Instance	0x01			
Attributes	Id	Name	Data Type	Access Rule
	0x1	802.1Q Tag Enable	USINT	Set
	0x4	DSCP Urgent	USINT	Set
	0x5	DSCP Scheduled	USINT	Set
	0x6	DSCP High	USINT	Set
	0x7	DSCP Low	USINT	Set
0x8	DSCP Explicit	USINT	Set	

2.3.15 TCP/IP Interface (0xF5)

	Value	Name		
Services	0x01	Get_Attributes_All		
	0x0E	Get_Attributes_Single		
	0x10	Set_Attributes_Single		
Class	0xF5			
Instance	0x01			
Attributes	Id	Name	Data Type	Access Rule
	0x1	Status	USINT	Get
	0x2	Interface capability	USINT	Get
	0x3	Interface control	USINT	Get/Set
	0x4	Path to physical link object	USINT	Get
	0x5	TCP/IP network interface config.	UDINT[5],String	Get/Set
	0x6	Host Name	STRING	Get/Set
	0xA	SelectAcid	BOOL	Get/Set
	0xB	LastConflictDetected	USINT[35]	Get/Set

2.3.16 Ethernet Link (0xF6)

	Value	Name		
Services	0x01	Get_Attributes_All		
	0x0E	Get_Attributes_Single		
	0x10	Set_Attributes_Single		
Class	0xF6			
Instance	0x01			
Attributes	Id	Name	Data Type	Access Rule
	0x1	Interface Speed	UDINT	Get
	0x2	Interface Flags	DWORD	Get
	0x3	Physical Address	USINT[6]	Get
	0x4	Interface Counters	UDINT[11]	Get
	0x5	Media Counters	UDINT[12]	Get
	0x6	Interface Control	WORD, UINT	Set
	0x7	Interface Type	USINT	Get
	0x8	Interface State	USINT	Get
0xA	Interface Label	SHORT-STRING	Get	

2.4 Implicit Messaging

Implicit messaging is primarily intended for motion control functionality. Over implicit messaging, the servo controller can be controlled in accordance to CANopen DS402 drive profile. Because CIPsync is not implemented, the transfer rate for implicit messaging cannot be guaranteed.

Reference mode, profile position mode, jog mode and cyclic synchronous position mode (Buffered or CIPsync mode) are supported. See demo applications for details. The minimum packet interval (RPI) of implicit messaging is 1ms.

2.4.1 Connections

Parameters	Standard	I Force	Digital Outputs	Force	CIP Sync	Input Only / Listen Only
Output Parameter						
TargetPositionOrDistance	X	X	X	X	X	
SpeedJogOrProfilePositionMode	X	X	X	X	X	
AccelerationJogOrProfilePositionMode	X	X	X	X	X	
SCurve	X	X	X	X	X	
Controlword	X	X	X	X	X	
LimitIForce		X	X	X	X	
FollowingPositionErrorWindow			X	X	X	
TargetPositionWindow			X	X	X	
DigitalOutputsXENAX			X	X	X	
LimitForce				X	X	
CIP Sync Timestamp					X	
Input Parameter						
Statusword	X	X	X	X	X	X
MotorCurrentActualValue	X	X	X	X	X	X
PositionActualValue	X	X	X	X	X	X
IForceActual	X	X	X	X	X	X
ProcessStatusRegisterXENAX	X	X	X	X	X	X
ActualPositionFollowingError	X	X	X	X	X	X
DigitalInputsXENAX	X	X	X	X	X	X
DigitalOutputsXENAX	X	X	X	X	X	X
ForceActual				X	X	
Cip Sync Timestamp					X	

2.4.2 Output Assembly

There are four different output assemblies to choose from as well as the option to disable the output assembly completely.

2.4.2.1 Standard

The standard Assembly is used for basic movement functions.

Instance	Octet	Name	Corresponding Attribute			
			Class	Instance	Attribute ID	Data Type
101 (18 byte)	0	TargetPositionOrDistance (bit 0-7)	0x66	1	0x3A	DINT
	1	TargetPositionOrDistance (bit 8-15)				
	2	TargetPositionOrDistance (bit 16-23)				
	3	TargetPositionOrDistance (bit 24-31)				
	4	SpeedJogOrProfilePositionMode (bit 0-7)	0x66	1	0x41	DINT
	5	SpeedJogOrProfilePositionMode (bit 8-15)				
	6	SpeedJogOrProfilePositionMode (bit 16-23)				
	7	SpeedJogOrProfilePositionMode (bit 24-31)				
	8	AccelerationJogOrProfilePositionMode (bit 0-7)	0x66	1	0x43	DINT
	9	AccelerationJogOrProfilePositionMode (bit 8-15)				
	10	AccelerationJogOrProfilePositionMode (bit 16-23)				
	11	AccelerationJogOrProfilePositionMode (bit 24-31)				
	12	SCurve (bit 0-7)	0x64	1	0x00	DINT
	13	SCurve (bit 8-15)				
	14	SCurve (bit 16-23)				
	15	SCurve (bit 24-31)				
	16	Controlword (bit 0-7)	0x66	1	0x00	INT
17	Controlword (bit 8-15)					

2.4.2.2 I Force

The limit I Force assembly I used to drive with I_Force limitation.

Instance	Octet	Name	Corresponding Attribute			
			Class	Instance	Attribute ID	Data Type
102 (20 byte)	0	TargetPositionOrDistance (bit 0-7)	0x66	1	0x3A	DINT
	1	TargetPositionOrDistance (bit 8-15)				
	2	TargetPositionOrDistance (bit 16-23)				
	3	TargetPositionOrDistance (bit 24-31)				
	4	SpeedJogOrProfilePositionMode (bit 0-7)	0x66	1	0x41	DINT
	5	SpeedJogOrProfilePositionMode (bit 8-15)				
	6	SpeedJogOrProfilePositionMode (bit 16-23)				
	7	SpeedJogOrProfilePositionMode (bit 24-31)				
	8	AccelerationJogOrProfilePositionMode (bit 0-7)	0x66	1	0x43	DINT
	9	AccelerationJogOrProfilePositionMode (bit 8-15)				
	10	AccelerationJogOrProfilePositionMode (bit 16-23)				
	11	AccelerationJogOrProfilePositionMode (bit 24-31)				
	12	SCurve (bit 0-7)	0x64	1	0x00	DINT
	13	SCurve (bit 8-15)				
	14	SCurve (bit 16-23)				
	15	SCurve (bit 24-31)				
	16	Controlword (bit 0-7)	0x66	1	0x00	INT
	17	Controlword (bit 8-15)				
	18	LimitIForce (bit 0-7)	0x66	1	0x33	INT
19	LimitIForce (bit 8-15)					

2.4.2.1 Digital Outputs

The Digital Outputs Assembly contains additional parameters for drive controlling and a parameter to set the digital outputs of the XENAX®.

Instance	Octet	Name	Corresponding Attribute			
			Class	Instance	Attribute ID	Data Type
103 (32 byte)	0	TargetPositionOrDistance (bit 0-7)	0x66	1	0x3A	DINT
	1	TargetPositionOrDistance (bit 8-15)				
	2	TargetPositionOrDistance (bit 16-23)				
	3	TargetPositionOrDistance (bit 24-31)				
	4	SpeedJogOrProfilePositionMode (bit 0-7)	0x66	1	0x41	DINT
	5	SpeedJogOrProfilePositionMode (bit 8-15)				
	6	SpeedJogOrProfilePositionMode (bit 16-23)				
	7	SpeedJogOrProfilePositionMode (bit 24-31)				
	8	AccelerationJogOrProfilePositionMode (bit 0-7)	0x66	1	0x43	DINT
	9	AccelerationJogOrProfilePositionMode (bit 8-15)				
	10	AccelerationJogOrProfilePositionMode (bit 16-23)				
	11	AccelerationJogOrProfilePositionMode (bit 24-31)				
	12	SCurve (bit 0-7)	0x64	1	0x00	DINT
	13	SCurve (bit 8-15)				
	14	SCurve (bit 16-23)				
	15	SCurve (bit 24-31)				
	16	Controlword (bit 0-7)	0x66	1	0x00	INT
	17	Controlword (bit 8-15)				
	18	LimitIForce (bit 0-7)	0x66	1	0x33	INT
	19	LimitIForce (bit 8-15)				
	20	FollowingPositionErrorWindow (bit 0-7)	0x66	1	0x25	DINT
	21	FollowingPositionErrorWindow (bit 8-15)				
	22	FollowingPositionErrorWindow (bit 16-23)				
	23	FollowingPositionErrorWindow (bit 24-31)				
	24	TargetPositionWindow (bit 0-7)	0x66	1	0x27	DINT
	25	TargetPositionWindow (bit 8-15)				
	26	TargetPositionWindow (bit 16-23)				
	27	TargetPositionWindow (bit 24-31)				
	28	DigitalOutputsXENAX (bit 0-7)	0x66	1	0xBF	DINT
	29	DigitalOutputsXENAX (bit 8-15)				
	30	DigitalOutputsXENAX (bit 16-23)				
	31	DigitalOutputsXENAX (bit 24-31)				

2.4.3.1 Force

The Force Assembly is needed for the external force sensor Signateq®.

Instance	Octet	Name	Corresponding Attribute			
			Class	Instance	Attribute ID	Data Type
104 (36 byte)	0	TargetPositionOrDistance (bit 0-7)	0x66	1	0x3A	DINT
	1	TargetPositionOrDistance (bit 8-15)				
	2	TargetPositionOrDistance (bit 16-23)				
	3	TargetPositionOrDistance (bit 24-31)				
	4	SpeedJogOrProfilePositionMode (bit 0-7)	0x66	1	0x41	DINT
	5	SpeedJogOrProfilePositionMode (bit 8-15)				
	6	SpeedJogOrProfilePositionMode (bit 16-23)				
	7	SpeedJogOrProfilePositionMode (bit 24-31)				
	8	AccelerationJogOrProfilePositionMode (bit 0-7)	0x66	1	0x43	DINT
	9	AccelerationJogOrProfilePositionMode (bit 8-15)				
	10	AccelerationJogOrProfilePositionMode (bit 16-23)				
	11	AccelerationJogOrProfilePositionMode (bit 24-31)				
	12	SCurve (bit 0-7)	0x64	1	0x00	DINT
	13	SCurve (bit 8-15)				
	14	SCurve (bit 16-23)				
	15	SCurve (bit 24-31)				
	16	Controlword (bit 0-7)	0x66	1	0x00	INT
	17	Controlword (bit 8-15)				
	18	LimitIForce (bit 0-7)	0x66	1	0x33	INT
	19	LimitIForce (bit 8-15)				
	20	FollowingPositionErrorWindow (bit 0-7)	0x66	1	0x25	DINT
	21	FollowingPositionErrorWindow (bit 8-15)				
	22	FollowingPositionErrorWindow (bit 16-23)				
	23	FollowingPositionErrorWindow (bit 24-31)				
	24	TargetPositionWindow (bit 0-7)	0x66	1	0x27	DINT
	25	TargetPositionWindow (bit 8-15)				
	26	TargetPositionWindow (bit 16-23)				
	27	TargetPositionWindow (bit 24-31)				
	28	DigitalOutputsXENAX (bit 0-7)	0x66	1	0xBF	DINT
	29	DigitalOutputsXENAX (bit 8-15)				
	30	DigitalOutputsXENAX (bit 16-23)				
	31	DigitalOutputsXENAX (bit 24-31)				
	32	LimitForce (bit 0-7)	0x64	1	0x09	DINT
	33	LimitForce (bit 8-15)				
	34	LimitForce (bit 16-23)				
35	LimitForce (bit 24-31)					

2.4.3.1 CIP Sync

The CIP Sync assembly includes everything contained in the Force assembly, along with a CIP Sync Timestamp.

Instance	Octet	Name	Corresponding Attribute			
			Class	Instance	Attribute ID	Data Type
112 (48 byte)	0	TargetPositionOrDistance (bit 0-7)	0x66	1	0x3A	DINT
	1	TargetPositionOrDistance (bit 8-15)				
	2	TargetPositionOrDistance (bit 16-23)				
	3	TargetPositionOrDistance (bit 24-31)				
	4	SpeedJogOrProfilePositionMode (bit 0-7)	0x66	1	0x41	DINT
	5	SpeedJogOrProfilePositionMode (bit 8-15)				
	6	SpeedJogOrProfilePositionMode (bit 16-23)				
	7	SpeedJogOrProfilePositionMode (bit 24-31)				
	8	AccelerationJogOrProfilePositionMode (bit 0-7)	0x66	1	0x43	DINT
	9	AccelerationJogOrProfilePositionMode (bit 8-15)				
	10	AccelerationJogOrProfilePositionMode (bit 16-23)				
	11	AccelerationJogOrProfilePositionMode (bit 24-31)				
	12	SCurve (bit 0-7)	0x64	1	0x00	DINT
	13	SCurve (bit 8-15)				
	14	SCurve (bit 16-23)				
	15	SCurve (bit 24-31)				
	16	Controlword (bit 0-7)	0x66	1	0x00	INT
	17	Controlword (bit 8-15)				
	18	LimitIForce (bit 0-7)	0x66	1	0x33	INT
	19	LimitIForce (bit 8-15)				
	20	FollowingPositionErrorWindow (bit 0-7)	0x66	1	0x25	DINT
	21	FollowingPositionErrorWindow (bit 8-15)				
	22	FollowingPositionErrorWindow (bit 16-23)				
	23	FollowingPositionErrorWindow (bit 24-31)				
	24	TargetPositionWindow (bit 0-7)	0x66	1	0x27	DINT
	25	TargetPositionWindow (bit 8-15)				
	26	TargetPositionWindow (bit 16-23)				
	27	TargetPositionWindow (bit 24-31)				
	28	DigitalOutputsXENAX (bit 0-7)	0x66	1	0xBF	DINT
	29	DigitalOutputsXENAX (bit 8-15)				
	30	DigitalOutputsXENAX (bit 16-23)				
	31	DigitalOutputsXENAX (bit 24-31)				
	32	LimitForce (bit 0-7)	0x64	1	0x09	DINT
	33	LimitForce (bit 8-15)				
	34	LimitForce (bit 16-23)				
	35	LimitForce (bit 24-31)				
36	Padding (bit 0-7)	-	-	-	DINT	

	37	Padding (bit 8-15)				
	38	Padding (bit 16-23)				
	39	Padding (bit 24-31)				
	40	CIP Sync Timestamp (bit 00-07)	-	-	-	LINT
	41	CIP Sync Timestamp (bit 08-15)				
	42	CIP Sync Timestamp (bit 16-23)				
	43	CIP Sync Timestamp (bit 24-31)				
	44	CIP Sync Timestamp (bit 32-39)				
	45	CIP Sync Timestamp (bit 40-47)				
	46	CIP Sync Timestamp (bit 48-55)				
	47	CIP Sync Timestamp (bit 56-63)				

2.4.4 Input Assembly

There are two input assemblies. For the Output Assemblies Standard, I Force and Outputs, the Standart Input Assembly is used. For the Output Assembly Full, the Input Assembly Full is used.

2.4.4.1 Standard

Instance	Octet	Name	Corresponding Attribute			
			Class	Instance	Attribute ID	Data Type
100 (28 byte)	0	Statusword (bit 0-7)	0x66	1	0x01	INT
	1	Statusword (bit 8-15)				
	2	MotorCurrentActualValue (bit 0-7)	0x66	1	0x38	INT
	3	MotorCurrentActualValue (bit 8-15)				
	4	PositionActualValue (bit 0-7)	0x66	1	0x24	DINT
	5	PositionActualValue (bit 8-15)				
	6	PositionActualValue (bit 16-23)				
	7	PositionActualValue (bit 24-31)				
	8	IForceActual (bit 0-7)	0x64	1	0x05	DINT
	9	IForceActual (bit 8-15)				
	10	IForceActual (bit 16-23)				
	11	IForceActual (bit 24-31)				
	12	ProcessStatusRegisterXENAX (bit 0-7)	0x64	1	0x06	DINT
	13	ProcessStatusRegisterXENAX (bit 8-15)				
	14	ProcessStatusRegisterXENAX (bit 16-23)				
	15	ProcessStatusRegisterXENAX (bit 24-31)				
	16	ActualPositionFollowingError (bit 0-7)	0x66	1	0xB4	DINT
	17	ActualPositionFollowingError (bit 8-15)				
	18	ActualPositionFollowingError (bit 16-23)				
	19	ActualPositionFollowingError (bit 24-31)				
	20	DigitalInputsXENAX (bit 0-7)	0x66	1	0xBD	DINT
	21	DigitalInputsXENAX (bit 8-15)				
	22	DigitalInputsXENAX (bit 16-23)				
	23	DigitalInputsXENAX (bit 24-31)				
	24	DigitalOutputsXENAX (bit 0-7)	0x66	1	0xBF	DINT
	25	DigitalOutputsXENAX (bit 8-15)				
	26	DigitalOutputsXENAX (bit 16-23)				
27	DigitalOutputsXENAX (bit 24-31)					

2.4.4.1 Force

Instance	Octet	Name	Corresponding Attribute			
			Class	Instance	Attribute ID	Data Type
105 (32 byte)	0	Statusword (bit 0-7)	0x66	1	0x01	INT
	1	Statusword (bit 8-15)				
	2	MotorCurrentActualValue (bit 0-7)	0x66	1	0x38	INT
	3	MotorCurrentActualValue (bit 8-15)				
	4	PositionActualValue (bit 0-7)	0x66	1	0x24	DINT
	5	PositionActualValue (bit 8-15)				
	6	PositionActualValue (bit 16-23)				
	7	PositionActualValue (bit 24-31)				
	8	IForceActual (bit 0-7)	0x64	1	0x05	DINT
	9	IForceActual (bit 8-15)				
	10	IForceActual (bit 16-23)				
	11	IForceActual (bit 24-31)				
	12	ProcessStatusRegisterXENAX (bit 0-7)	0x64	1	0x06	DINT
	13	ProcessStatusRegisterXENAX (bit 8-15)				
	14	ProcessStatusRegisterXENAX (bit 16-23)				
	15	ProcessStatusRegisterXENAX (bit 24-31)				
	16	ActualPositionFollowingError (bit 0-7)	0x66	1	0xB4	DINT
	17	ActualPositionFollowingError (bit 8-15)				
	18	ActualPositionFollowingError (bit 16-23)				
	19	ActualPositionFollowingError (bit 24-31)				
	20	DigitalInputsXENAX (bit 0-7)	0x66	1	0xBD	DINT
	21	DigitalInputsXENAX (bit 8-15)				
	22	DigitalInputsXENAX (bit 16-23)				
	23	DigitalInputsXENAX (bit 24-31)				
	24	DigitalOutputsXENAX (bit 0-7)	0x66	1	0xBF	DINT
	25	DigitalOutputsXENAX (bit 8-15)				
	26	DigitalOutputsXENAX (bit 16-23)				
	27	DigitalOutputsXENAX (bit 24-31)				
	28	ForceActual (bit 0-7)	0x64	1	0xA	DINT
	29	ForceActual (bit 8-15)				
	30	ForceActual (bit 16-23)				
31	ForceActual (bit 24-31)					

2.4.4.1 CIP Sync

Instance	Octet	Name	Corresponding Attribute			
			Class	Instance	Attribute ID	Data Type
113 (40 byte)	0	Statusword (bit 0-7)	0x66	1	0x01	INT
	1	Statusword (bit 8-15)				
	2	MotorCurrentActualValue (bit 0-7)	0x66	1	0x38	INT
	3	MotorCurrentActualValue (bit 8-15)				
	4	PositionActualValue (bit 0-7)	0x66	1	0x24	DINT
	5	PositionActualValue (bit 8-15)				
	6	PositionActualValue (bit 16-23)				
	7	PositionActualValue (bit 24-31)				
	8	IForceActual (bit 0-7)	0x64	1	0x05	DINT
	9	IForceActual (bit 8-15)				
	10	IForceActual (bit 16-23)				
	11	IForceActual (bit 24-31)				
	12	ProcessStatusRegisterXENAX (bit 0-7)	0x64	1	0x06	DINT
	13	ProcessStatusRegisterXENAX (bit 8-15)				
	14	ProcessStatusRegisterXENAX (bit 16-23)				
	15	ProcessStatusRegisterXENAX (bit 24-31)				
	16	ActualPositionFollowingError (bit 0-7)	0x66	1	0xB4	DINT
	17	ActualPositionFollowingError (bit 8-15)				
	18	ActualPositionFollowingError (bit 16-23)				
	19	ActualPositionFollowingError (bit 24-31)				
	20	DigitalInputsXENAX (bit 0-7)	0x66	1	0xBD	DINT
	21	DigitalInputsXENAX (bit 8-15)				
	22	DigitalInputsXENAX (bit 16-23)				
	23	DigitalInputsXENAX (bit 24-31)				
	24	DigitalOutputsXENAX (bit 0-7)	0x66	1	0xBF	DINT
	25	DigitalOutputsXENAX (bit 8-15)				
	26	DigitalOutputsXENAX (bit 16-23)				
	27	DigitalOutputsXENAX (bit 24-31)				
	28	ForceActual (bit 0-7)	0x64	1	0xA	DINT
	29	ForceActual (bit 8-15)				
	30	ForceActual (bit 16-23)				
	31	ForceActual (bit 24-31)				
	32	CIP Sync Timestamp (bit 00-07)	-	-	-	LINT
	33	CIP Sync Timestamp (bit 08-15)				
	34	CIP Sync Timestamp (bit 16-23)				
	35	CIP Sync Timestamp (bit 24-31)				
	36	CIP Sync Timestamp (bit 32-39)				
	37	CIP Sync Timestamp (bit 40-47)				
	38	CIP Sync Timestamp (bit 48-55)				
39	CIP Sync Timestamp (bit 56-63)					

3 DS402 drive profile

3.1 DS402 state machine

The basic motion control functions of the XENAX® servo controller are controlled over a CANopen DS402 state machine. This DS402 state machine is controlled over the vendor specific object 0x66 (XENAX® Drive Parameter Object) or with its attributes mapped to the assembly object respectively. Following, the state diagram of the DS402 state machine is shown, where all states and transitions can be controlled and supervised with the controlword and statusword.

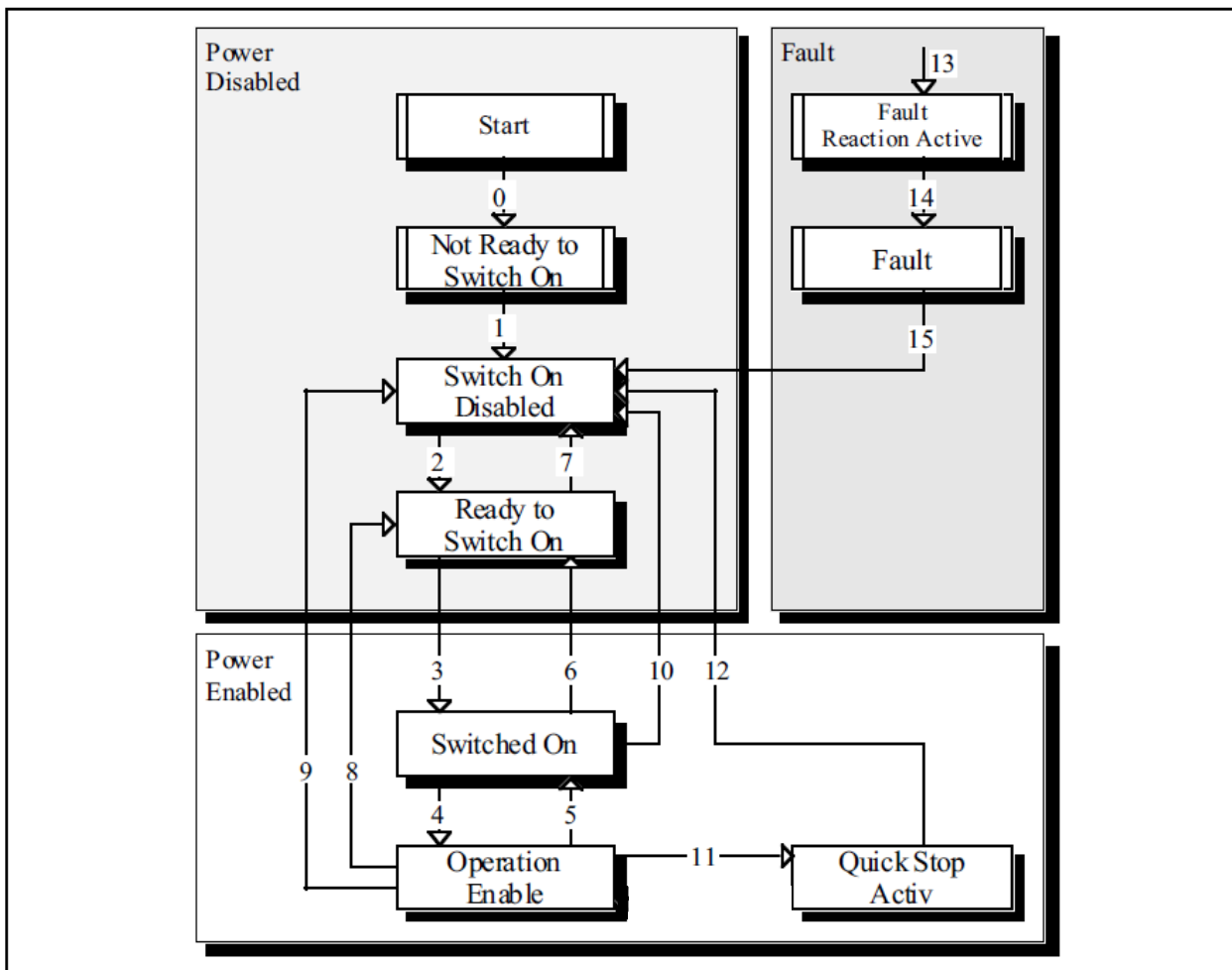

3.2 Examples

3.2.1 Reference

Mode specific bits of the Controlword

Bit 4	Reference start
-------	-----------------

Mode specific bits of the Statusword

Bit 12	Reference achieved
Bit 13	Reference error

3.2.1.1 Linear axis

With linear motor axes, as first action after power on, the reference drive must be done. Do reference drive also after logic power interruption. Otherwise the automatic adjustment of the electrical angle between magnets and coil poles will not be done. If an error occurs i.e. 50, no reference drive is necessary, because with the logical power the position counter remains active.

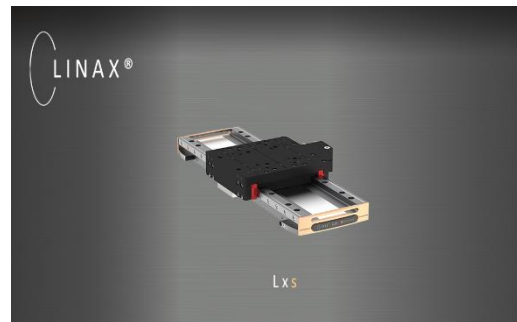

Parameter	Description	Value	Activities
0x66, Id 0x20	Modes of Operation requested	0x06	Set Reference Mode
0x66, Id 0x21	Modes of Operation display		Wait until Reference Mode is active, Value = 0x06
0x66, Id 0x58	Reference method linear	0x ...	0x01 REFERENCE, start direction positive 0x02 REFERENCE, start direction negative
0x66, Id 0x00	Controlword	0x06	Switch to state "Ready to switch on"
0x66, Id 0x01	Statusword		Wait until state "Ready to switch on" is reached => Statusword = xxxx xxxx x01x 0001 _b
0x66, Id 0x00	Controlword	0x07	Switch to state "Switched on"
0x66, Id 0x01	Statusword		Wait until state "Switched on" is reached => Statusword = xxxx xxxx x01x 0011 _b
0x66, Id 0x00	Controlword	0x0F	Switch to state "Operation enable" -> Powerstage active
0x66, Id 0x01	Statusword		Wait until state "Operation enable" is reached => Statusword = xxxx xxxx x01x 0111 _b
0x66, Id 0x00	Controlword	0x1F	Reference operation starts
0x66, Id 0x01	Statusword		Wait until reference is finished => Bit 12 in Statusword (Reference achieved) is set
0x66, Id 0x20	Modes of operation requested	0x08 0x01	Set the mode of operation to the desired driving mode. 0x08 for cyclic synchronous position mode or 0x01 for profile position mode.
0x66, Id 0x21	Modes of operation display		Wait until Reference Mode equal to the requested mode.
Continue driving as specified in the DS402 standard.			

3.2.2.1 Linear gantry systems

Reference of a linear gantry system is using the master-slave connection of the XENAX® servo controller.
The gantry initialization is a stand-alone process controlled by master XENAX® servo controller.

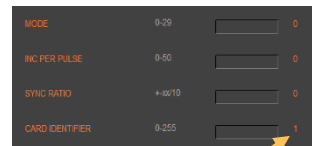
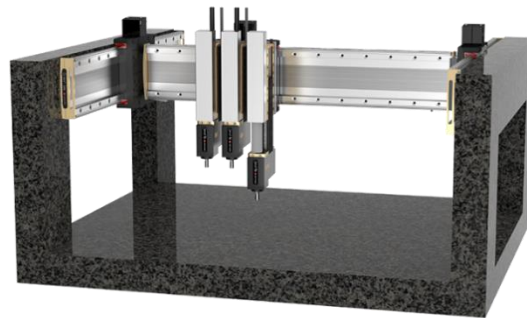

Corresponds to CI

Master-Slave
USB A-A cable

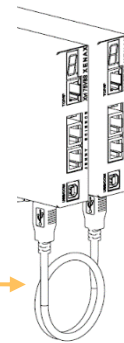

Object	Description	Value	Activities
0x66, Id 0x20	Modes of Operation requested	0x06	Set Reference Mode
0x66, Id 0x21	Modes of Operation display		Wait until Reference Mode is active, Value = 0x06
0x66, Id 0x58	Reference method gantry	0x ...	Depending on mechanical fitting of the gantry axes 0x03 REF, gantry system, direction positive, linear motor axes same measurement system orientation 0x04 REF, gantry system, direction negative, linear motor axes same measurement system orientation 0x05 REF, gantry system, direction positive, linear motors axes contrary measurement system orientation 0x06 REF, gantry system, direction negative, linear motors axes contrary measurement system orientation
0x66, Id 0x00	Controlword	0x06	Ready to Switch on
0x66, Id 0x01	Statusword		Wait until state "Ready to switch on" is reached => Statusword = xxxx xxxx x01x 0001 _b
0x66, Id 0x00	Controlword	0x07	Switch to state "Switched on"
0x66, Id 0x01	Statusword		Wait until state "Switched on" is reached => Statusword = xxxx xxxx x01x 0011 _b
0x66, Id 0x00	Controlword	0x0F	Switch to state "Operation enable" -> Powerstage active
0x66, Id 0x01	Statusword		Wait until state "Operation enable" is reached => Statusword = xxxx xxxx x01x 0111 _b
0x66, Id 0x00	Controlword	0x1F	Reference operation starts
0x66, Id 0x01	Statusword		Wait until reference is finished => Bit 12 in Statusword (Reference achieved) is set
0x66, Id 0x20	Modes of operation requested	0x08 0x01	Set the mode of operation to the desired driving mode. 0x08 for cyclic synchronous position mode or 0x01 for profile position mode.
0x66, Id 0x21	Modes of operation display		Wait until Reference Mode equal to the requested mode.
Continue driving as specified in the DS402 standard.			

3.2.2.2 Rotative third party motors

In a typical configuration of rotative axis, there is an external reference sensor to find the mechanical reference range.

After finding the external reference sensor, lock for the precise reference position with the internal Z-mark on the encoder.



Object	Description	Value	Activities
0x66, Id 0x20	Modes of Operation requested	0x06	Set Reference Mode
0x66, Id 0x21	Modes of Operation display		Wait until Reference Mode is active, Value = 0x06
0x66, Id 0x58	Reference method rotative	0x ...	0x0A REFERENCE, start clockwise -> external reference Sensor, continue counter clockwise -> Z-mark 0x0B REFERENCE, start clockwise -> external reference Sensor, continue clockwise -> Z-mark 0x0C REFERENCE, start counter clockwise -> external reference Sensor, continue counter clockwise -> Z-mark 0x0D REFERENCE, start, counter clockwise -> external reference Sensor, continue clockwise -> Z-mark
0x66, 0x5A	Reference -Speed for search the external reference sensor	Using 32	If there is no REFERENCE sensor, then set the reference Speed to 0
0x66, 0x5B	Z-Speed for search the internal encoder Z-mark	Using 32	If there is no Z-mark on the encoder, then set the Z-Speed to 0
0x66, Id 0x00	Controlword	0x06	Ready to Switch on
0x66, Id 0x01	Statusword		Wait until state "Ready to switch on" is reached => Statusword = xxxx xxxx x01x 0001 _b
0x66, Id 0x00	Controlword	0x07	Switch to state "Switched on"
0x66, Id 0x01	Statusword		Wait until state "Switched on" is reached => Statusword = xxxx xxxx x01x 0011 _b
0x66, Id 0x00	Controlword	0x0F	Switch to state "Operation enable" -> Powerstage active
0x66, Id 0x01	Statusword		Wait until state "Operation enable" is reached => Statusword = xxxx xxxx x01x 0111 _b
0x66, Id 0x00	Controlword	0x1F	Reference operation starts
0x66, Id 0x01	Statusword		Wait until reference is finished => Bit 12 in Statusword (Reference achieved) is set
0x66, Id 0x20	Modes of operation requested	0x08 0x01 -0x01	Set the mode of operation to the desired driving mode. 0x08 for cyclic synchronous position mode, 0x01 for profile position mode or -0x01 for jog velocity.
0x66, Id 0x21	Modes of operation display		Wait until Reference Mode equal to the requested mode.
Continue driving as specified in the DS402 standard.			

Notice:

To assign the external REFERENCE sensor to a physical Input, the Input number have to be programmed with WebMotion in menu programming / reference function.

3.2.2.3 ROTAX® Rxvp rotative motor

There are two more reference methods with the ROTAX® rotary motor axes to reference with the internal Z-mark on the encoder:

0x0E REFERENCE, start, clockwise -> external reference Sensor, shortest way -> Z-mark

0x0F REFERENCE, start, counter clockwise -> external reference Sensor, shortest way -> Z-mark



Rxvp = vacuum pressure

3.2.2.4 ROTAX® Rxhq rotative motor

Due to the absolute position, the ROTAX® Rxhq is immediately ready for operation after power-on, no reference drive is necessary. For this purpose, the Z-MARK DIR must be set to 0 and the REF INPUT to NONE. The position of the encoder immediately after startup always has a value between 0 and 119'999Inc.



Rxhq = high torque

3.2.2.5 Reset Reference failure

Object	Description	Value	Activities
0x66, Id 0x00	Controlword	0x80	Fault reset
0x66, Id 0x01	Statusword		Wait until fault is reset => Bit 3 in Statusword (Fault) is cleared
0x66, Id 0x00	Controlword	0x06	Ready to Switch on
0x66, Id 0x01	Statusword		Wait until state "Ready to switch on" is reached => Statusword = xxxx xxxx x01x 0001 _b
0x66, Id 0x00	Controlword	0x07	Switch to state "Switched on"
0x66, Id 0x01	Statusword		Wait until state "Switched on" is reached => Statusword = xxxx xxxx x01x 0011 _b
0x66, Id 0x00	Controlword	0x0F	Switch to state "Operation enable" -> Powerstage active
0x66, Id 0x01	Statusword		Wait until state "Operation enable" is reached => Statusword = xxxx xxxx x01x 0111 _b
0x66, Id 0x00	Controlword	0x1F	Reference operation starts
0x66, Id 0x01	Statusword		Wait until reference is finished => Bit 12 in Statusword (Reference achieved) is set
0x66, Id 0x20	Modes of operation requested	0x08 0x01 -0x01	Set the mode of operation to the desired driving mode. 0x08 for cyclic synchronous position mode, 0x01 for profile position mode or -0x01 for jog velocity.
0x66, Id 0x21	Modes of operation display		Wait until Reference Mode equal to the requested mode.

Continue driving as specified in the DS402 standard.

3.2.3 Profile Position Mode

With the Profile Position Mode the XENAX® servo controller get the profile parameters like S-curve, acceleration, speed, position etc. from the superior controller (PC, PLC). The position profile trajectory is calculated in the XENAX® servo controller.

* A new Position set point will only be accepted, if the actual running position profile reached the target position.

Mode specific bits in the Controlword

Bit 4	New Position
Bit 6	0: Absolute Position 1: Relative Distance

Mode specific bits in the Statusword

Bit 10	Target position reached
Bit 12	Acknowledge of moving to target position
Bit 13	Following position error

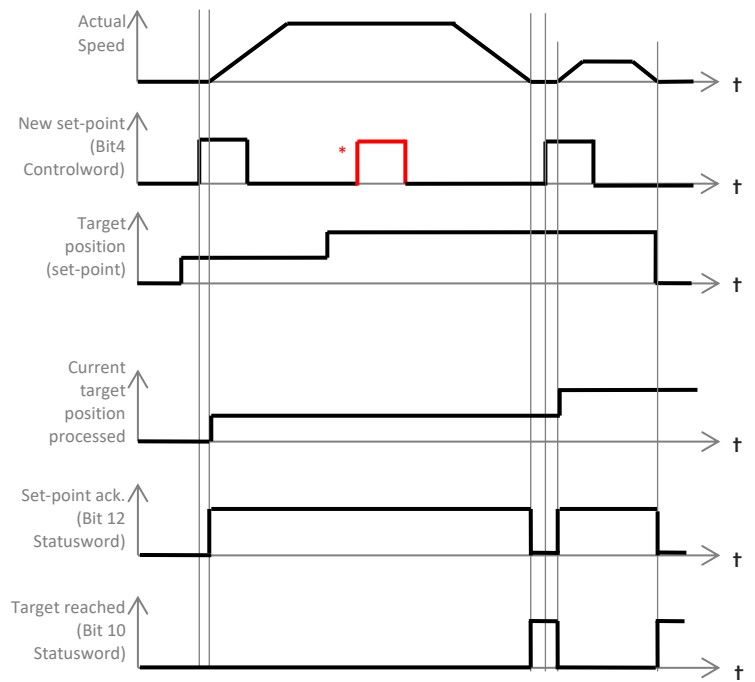

3.2.3.1 Example of profile position mode

Description	Value	Activities
Modes of operation requested	0x01	Set Profile Position Mode
Modes of operation displayed		Wait until Profile Position Mode is active, Value = 0x01
Controlword	0x0F	
Profile Position Mode parameters	0x...	Set desired S-Curve, Acceleration, Speed, Following Position Error Window, Target Position Window
TargetPositionOrDistance	0x...	Set desired target position
Controlword	0x1F	Start movement to target position absolute (Bit 6=0)
Statusword		Target position reached, Acknowledge of moving to target pos. Bit 10 =True, Bit 12 = False

Controlword	0x0F	
Profile Position Mode parameters	0x...	Set desired S-Curve, Acceleration, Speed, Following Position Error Window, Target Position Window
TargetPositionOrDistance	0x...	Set desired target position
Controlword	0x5F	Start movement to target position relative (Bit 6=1)
Statusword		Target position reached, Acknowledge of moving to target pos. Bit 10 =True, Bit 12 = False

3.2.3.2 Example of Reset Profile Position Mode Failure

Description	Value	Activities
Controlword	0x80	Fault reset
Statusword		Wait until fault is reset => Bit 3 in Statusword (Fault) is cleared
Controlword	0x06	Ready to Switch on (clear fault reset)
Continue with power on sequence. NO REFERENCE necessary.		

3.2.3.3 Example of Halt in Profile Position Mode

An ongoing profile position movement can be aborted by setting the “Halt” bit in Controlword (Bit 8). For the deceleration ramp, the currently set acceleration value in Class ID 66h, Instance ID 1, Attribute ID 67 respective the corresponding value in the output assembly is used at the time the “Halt” bit is set.

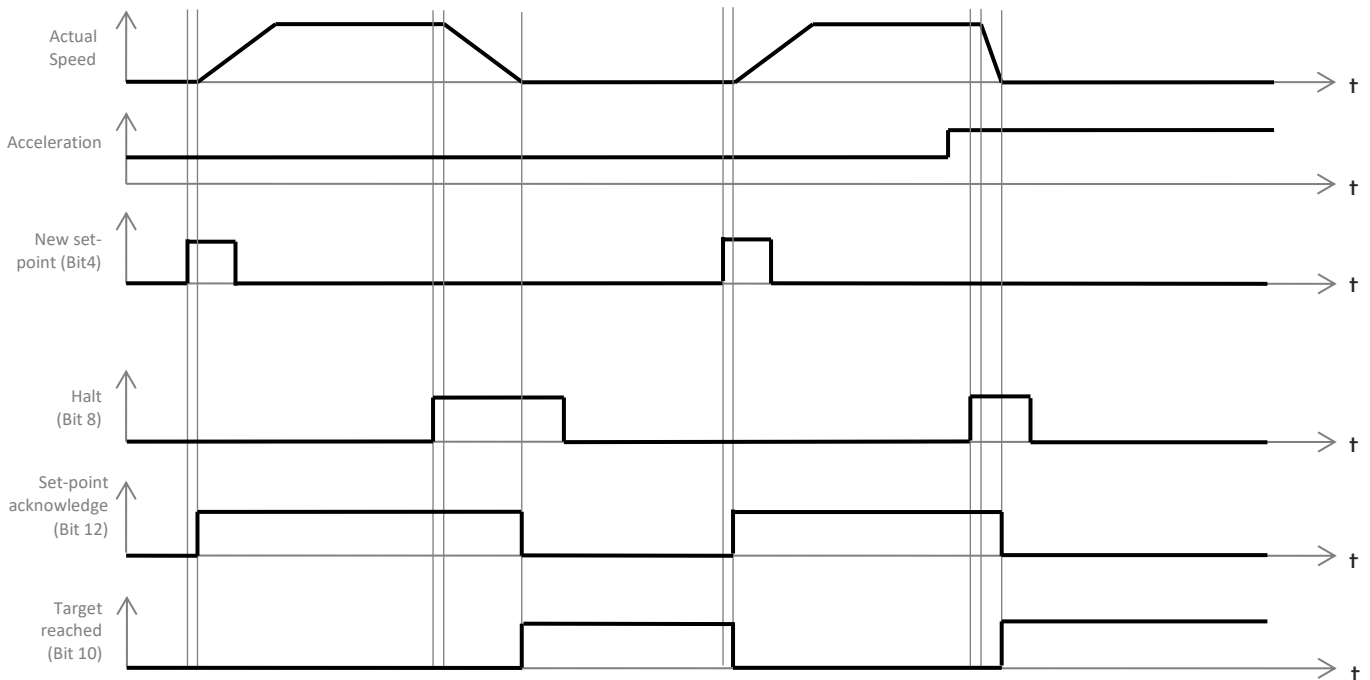

Description	Value	Activities
Controlword	0x0F	
Profile Position Mode parameters	0x...	Set desired S-Curve, Acceleration, Speed, Following Position Error Window, Target Position Window, TargetPositionOrDistance
Controlword	0x1F	Start movement to target position absolute
AccelerationJogOrProfilePositionMode	0x...	If necessary, change AccelerationJogOrProfilePositionMode for “Halt” command
Controlword	0x10F	Abort ongoing movement with “Halt” command
Statusword		Target position reached, Acknowledge of moving to target pos. Bit 10 =True, Bit 12 = False

3.2.4 Jog Mode Jenny Science specific

With the Jog Mode the XENAX® servo controller get the jog parameters like acceleration, speed, direction etc. from the superior controller (PC, PLC). The jog trajectory is calculated in the XENAX® servo controller.

During an ongoing movement, the acceleration and speed can be changed with immediately impact.

Important: Jog Mode is not allowed in gantry configuration.

Mode specific bits in the Controlword

Bit 4	Start Jog drive
Bit 6	0: Direction negative 1: Direction positive

Mode specific bits in the Statusword

Bit 10	Constant speed reached
Bit 12	Speed is equal 0

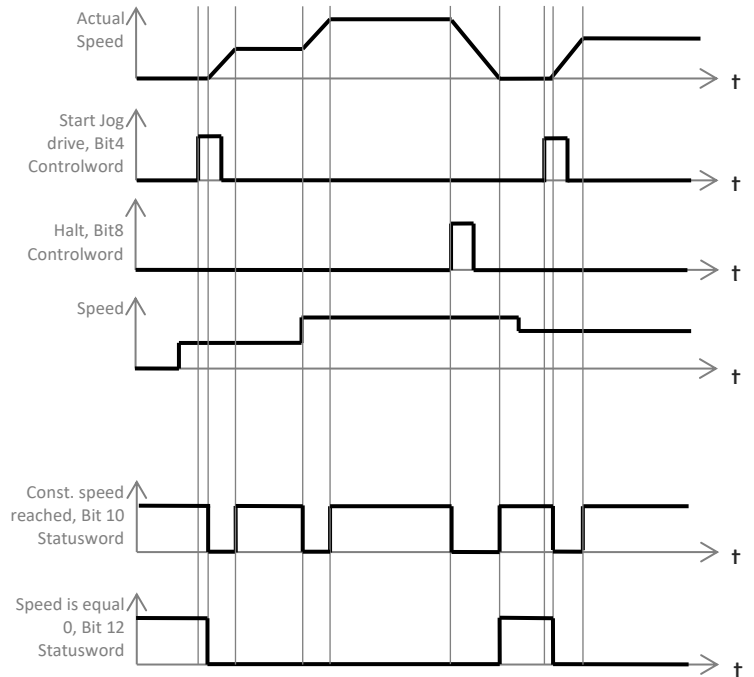

3.2.5.1 Example of Jog Mode Jenny Science specific

Description	Value	Activities
Modes of operation requested	0xFF	Set Jog Mode Jenny Science specific (-1)
Modes of operation displayed		Wait until Jog Mode is active, Value = 0xFF (-1)
Controlword	0x0F	
Jog Mode parameters	0x ...	Set desired, Acceleration, Speed, Following Position Error Window, Target Position Window
Controlword	0x1F	Start Jog drive in negative direction (Bit 6=0)
Statusword		Constant speed reached, Speed is not equal 0 Bit 10 =True, Bit 12 = False
Controlword	0x11F	Stop Jog drive (set Halt, Bit 8 = 1)
Statusword		Constant speed reached, Speed is equal 0 Bit 10 =True, Bit 12 = True

Description	Value	Activities
Modes of operation requested	0xFF	Set Jog Mode Jenny Science specific (-1)
Modes of operation displayed		Wait until Jog Mode is active, Value = 0xFF (-1)
Controlword	0x0F	
Jog Mode parameters	0x ...	Set desired, Acceleration, Speed, Following Position Error Window, Target Position Window
Controlword	0x5F	Start Jog drive in negative direction (Bit 6=1)
Statusword		Constant speed reached, Speed is not equal 0 Bit 10 =True, Bit 12 = False
Controlword	0x11F	Stop Jog drive (set Halt, Bit 8 = 1)
Statusword		Constant speed reached, Speed is equal 0 Bit 10 =True, Bit 12 = True

3.2.5.2 Example of Reset Jog Mode Failure

Description	Value	Activities
Controlword	0x80	Fault reset
Statusword		Wait until fault is reset => Bit 3 in Statusword (Fault) is cleared
Controlword	0x06	Ready to Switch on (clear fault reset)
Continue with power on sequence, if desired		

Notes

This instruction manual contains copyright protected information. All rights are reserved.

This document may not be in its entirety or partially copied, duplicated or translated without the prior consent of Jenny Science AG.

Jenny Science AG grants no guarantee on, or will be held responsible for, any incidents resulting from false information.

Information in this instruction manual is subject to change.

Jenny Science AG
Sandblatte 11
CH-6026 Rain, Schweiz

Tel +41 (0) 41 255 25 25

www.jennyscience.ch
info@jennyscience.ch